



DRAWER COMPARTMENT SYSTEM



Flexible compartment system



- > Can be adapted individually to the contents – prevents tipping over and falling out.
- > Optimum overview provided by transparent visible zones
- > Installation without tools.
- > Textiles machine washable at 30°.

- > Area of application: Drawer compartment system for cabinet width from 600 mm
- > Version: 1 frame, 5 flexible dividers
- > Material: Steel, plastic and textile
- > Dim. (W x D x H): 472 x 472 x 130 mm
- > Adjustment facility: Width: 472–520 mm
- > For nominal length: 500 mm
- > For cabinet width: ≥ 600 mm
- > Installation: For inserting into drawers

Finish/colour	Cat. No.
Steel: Chrome plated, plastic and textile: Grey	556.81.291

Packing: 1 piece

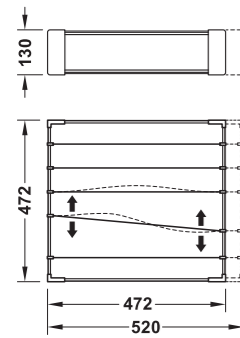
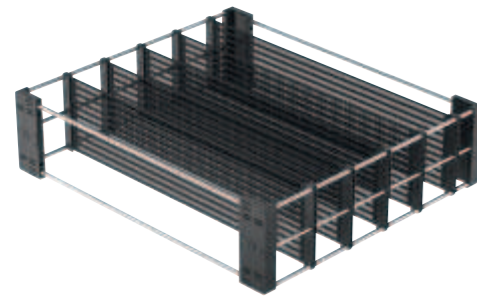

DGH-M 2017, HDE-en,10/16; Dimensional data not binding. We reserve the right to alter specifications without notice.

9
Drawer and Pull Out

17.09.2020
ID 5084

Flexible drawer compartment system

Made from wood



- > High-quality trays made from real wood
- > The combination of trays and non-slip mat allows a configuration which is independent of the width and drawer side runner system
- > Depth adjusting strips for nominal length up to 650 mm allow any drawer side runner system
- > 110 mm high inserts for pull out for door front fixing

- > Area of application: Compartment system for drawers, for width optional use in all common drawer side runner systems and wooden drawers
- > Material: Boxes/elements: Real wood, base panel: MDF 4 mm veneered with oak/ash black
- > Finish: Oak or ash black, stained, with PUR lacquer lacquered
- > For nominal length: From 500 mm

Drawer

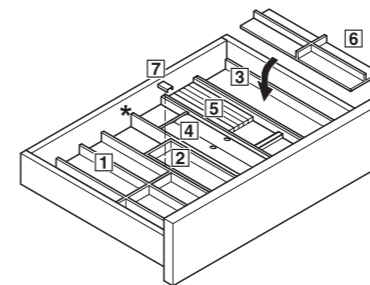

- ① Cutlery insert
- ② Tray
- ③ Multifunctional insert
- ④ Foil dispenser
- ⑤ Knife block
- ⑥ Cross divider insert
- ⑦ Aluminium clip
- * please order non-slip mat separately

Pull out for door front fixing

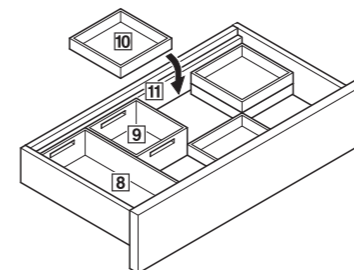

- ⑧ Box 1
- ⑨ Box 2
- ⑩ Box 3
- ⑪ Compensating strip

DGH-M 2017, HDE-en,10/16; Dimensional data not binding. We reserve the right to alter specifications without notice.

→ Inserts for drawer

① Cutlery insert

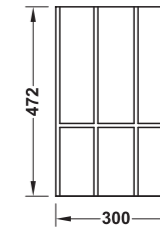

- > Height: 43 mm
- > Installation: Inserted separately or connected with aluminium clip

Finish	Cat. No.
Oak	550.31.400
Ash, black stained	550.31.300

Packing: 1 piece

② Tray

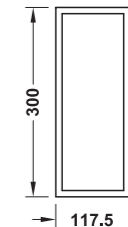

- > Height: 43 mm
- > Installation: Inserted separately or connected with aluminium clip

Finish	Cat. No.
Oak	550.31.420
Ash, black stained	550.31.320

Packing: 1 piece

③ Multifunctional insert

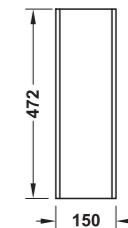

- > Height: 43 mm
- > Installation: Inserted separately or connected with aluminium clip

Finish	Cat. No.
Oak	550.31.410
Ash, black stained	550.31.310

Packing: 1 piece

Non-slip mat

► MB 7.25

9
Drawer and Pull Out

④ Foil dispenser

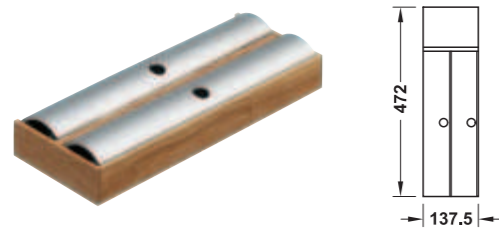

- > Material: Lid: Aluminium
- > Version: For 2 rolls of foil
- > Height: Wooden parts 37.5 mm
- > Installation: For inserting into ③ multifunctional insert

Finish	Cat. No.
Oak	550.31.430
Ash, black stained	550.31.330

Packing: 1 piece

⑤ Knife block

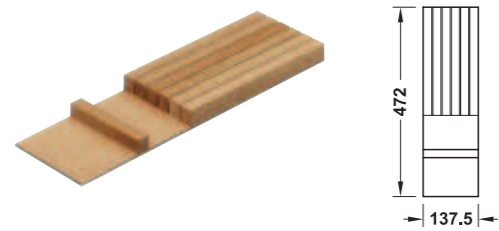

- > Version: For 5 knives
- > Height: 26 mm
- > Installation: For inserting into ③ multifunctional insert

Finish	Cat. No.
Oak	550.31.440
Ash, black stained	550.31.340

Packing: 1 piece

⑥ Cross divider insert



- > Height: 37.5 mm
- > Installation: For inserting into ③ multifunctional insert

Finish	Cat. No.
Oak	550.31.450
Ash, black stained	550.31.350

Packing: 1 piece

⑦ Aluminium clip



- > Installation: For connecting ① cutlery insert, ② tray and ③ multifunctional insert
- > Material: Aluminium

Finish	Cat. No.
Anodized E6Ev1	550.31.999

Packing: 1 piece

→ Inserts for pull out for door front fixing

⑧ Box 1



- > Height: 110 mm
- > Installation: Inserted separately or for stacking

Finish	Cat. No.
Oak	550.31.462
Ash, black stained	550.31.362

Packing: 1 piece

⑨ Box 2

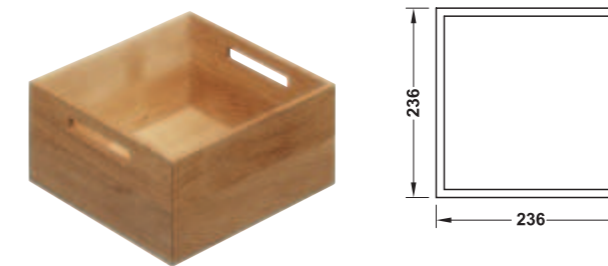

- > Height: 110 mm
- > Installation: Inserted separately or for stacking

Finish	Cat. No.
Oak	550.31.461
Ash, black stained	550.31.361

Packing: 1 piece

⑩ Box 3

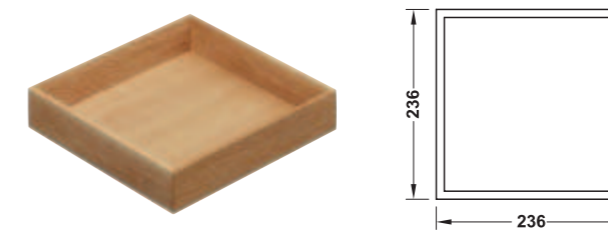

- > Height: 43 mm
- > Installation: Inserted separately or for stacking

Finish	Cat. No.
Oak	550.31.460
Ash, black stained	550.31.360

Packing: 1 piece

→ ⑪ Compensating strip for drawer and pull out for door front fixing

For nominal length of 500 mm



- > Area of application: For depth compensation of deeper drawers such as Matrix Box P or Grass Nova Pro Scala 600/1,200 mm
- > Length: 600/1,200 mm
- > Installation: Can be cut to size

For cabinet width mm	Oak	Ash, black stained
Up to 600	550.31.490	550.31.390
Up to 1200	550.31.492	550.31.392

Packing: 1 piece

For nominal length up to 650 mm



- > Area of application: For depth compensation with nominal lengths up to 650 mm
- > Length: 1,200 mm
- > Installation: For cutting across depth and width

For cabinet width mm	Oak	Ash, black stained
Up to 1200	550.31.491	550.31.391

Packing: 1 piece

Flexible cutlery insert

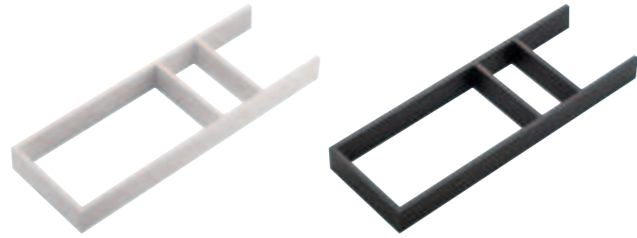

White, silk matt

Anthracite, silk matt

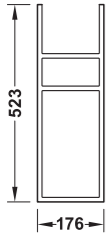

- > Area of application: For width optional use in all common drawer side runner systems
- > Material: Plastic
- > Dim.: Length: 523 mm, width: 176 mm, height: 50 mm, the insert can be cut on the open end as required.

Note
Unused surfaces can be equipped with a non-slip mat.

Colour	Cat. No.
White, silk matt	550.34.700
Anthracite, silk matt	550.34.400

Packing: 1 piece

Order reference
Several inserts can be combined. Please order non-slip mat separately.

Flexible multifunctional insert

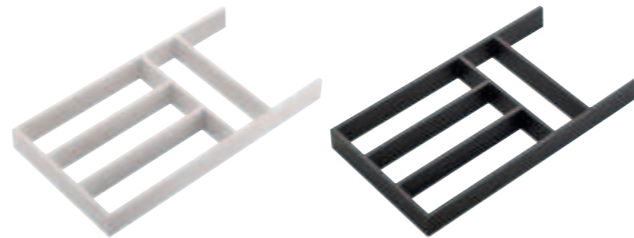

White, silk matt

Anthracite, silk matt

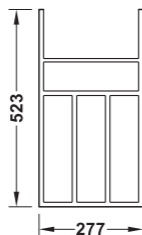

- > Area of application: For width optional use in all common drawer side runner systems
- > Material: Plastic
- > Dim.: Length: 523 mm, width: 277 mm, height: 50 mm, the insert can be cut on the open end as required.

Note
Unused surfaces can be equipped with a non-slip mat.

Colour	Cat. No.
White, silk matt	550.34.701
Anthracite, silk matt	550.34.401

Packing: 1 piece

Order reference
Several inserts can be combined. Please order non-slip mat separately.

Non-slip mat ▶ MB 7.25

DGH-M 2017, HIDE-en,10/16; Dimensional data not binding. We reserve the right to alter specifications without notice.

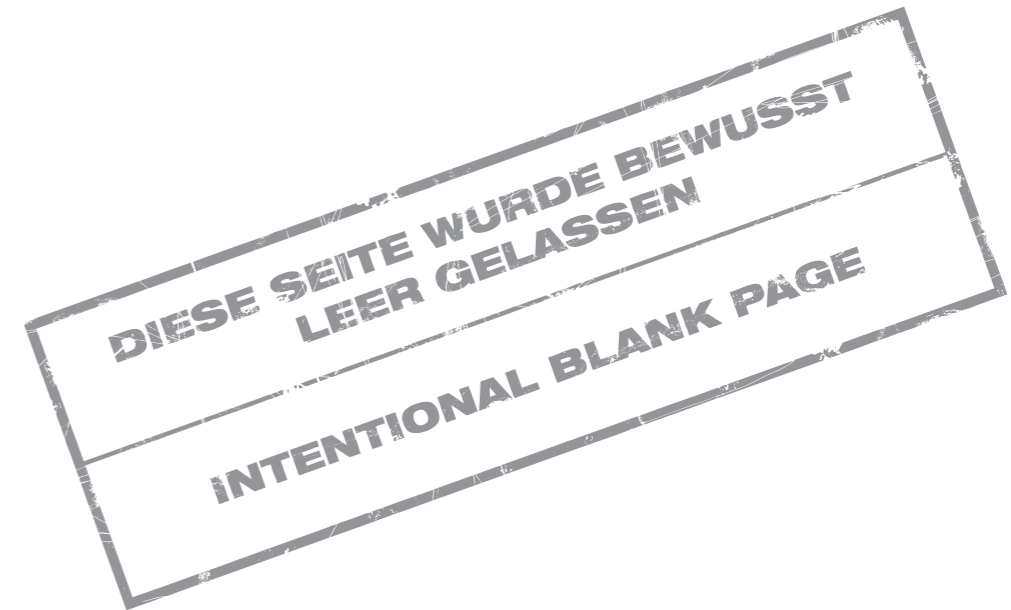

Drawer insert



- > New, integrated non-slip surface (only with colour anthracite pearl)
- > Particularly suitable for use beneath induction hobs (with height of 40 mm)

- > Area of application: For all common drawer side runner systems and wooden drawers
- > Material: Plastic
- > Colour: Anthracite pearl or white grained
- > For nominal length: 500 mm
- > Height: 40 or 52 mm
- > Depth: 460–530 mm
- > Installation: For cutting to size

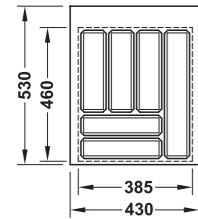

For cabinet width 500 mm

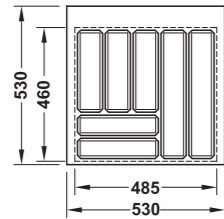

For cabinet width 600 mm

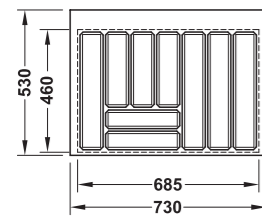

For cabinet width 800 mm

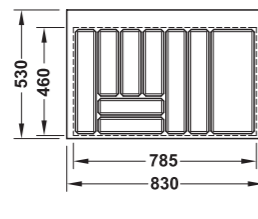

For cabinet width 900 mm

→ Height 40 mm

For cabinet width mm	Anthracite pearl	White grained
600	556.60.336	556.60.736
800	556.60.337	556.60.737
900	556.60.338	556.60.738

Packing: 1 piece

→ Height 52 mm

For cabinet width mm	Anthracite pearl	White grained
500	556.60.315	556.60.715
600	556.60.316	556.60.716
800	556.60.317	556.60.717
900	556.60.318	556.60.718

Packing: 1 piece

Partition

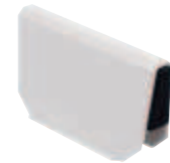

- > Area of application: For subdividing cutlery insert with height of 52 mm
- > Material: Plastic
- > Height: 50 mm

Colour	Cat. No.
weiß	556.60.749
anthrazit	556.60.349

Packing: 1 piece

DGH-M 2017, HDE-en,10/16; Dimensional data not binding. We reserve the right to alter specifications without notice.

Cutlery insert

For Matrix Box P,
Blum Legrabox, Blum Tandembox and Grass Nova Pro Scala drawer side runner systems

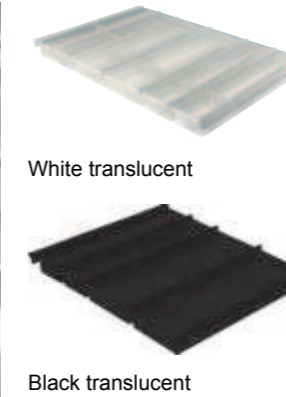

White translucent

Black translucent

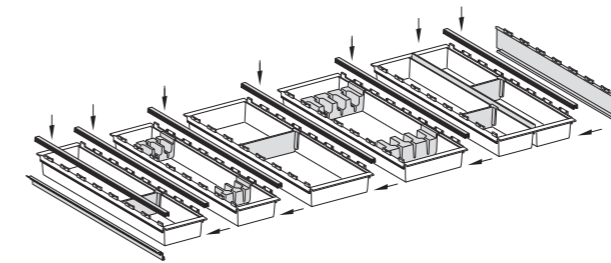

→ Blum Tandembox

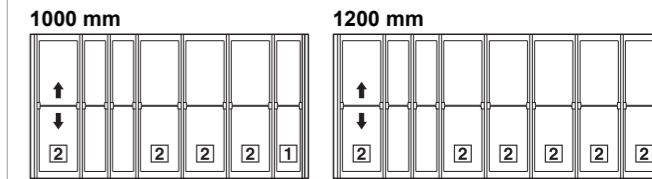
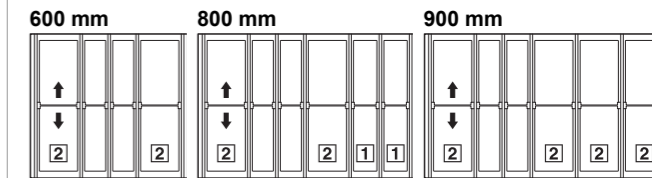
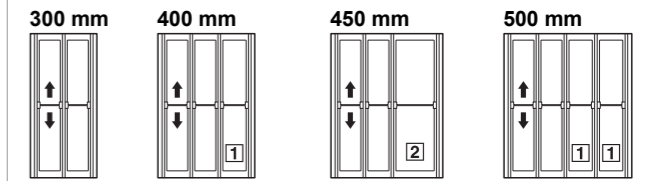

- > Material: Plastic (injection moulded), aluminium
- > Finish: Polished
- > Nom. length: 500 mm
- > Height: 55 mm
- > For internal drawer depth: 473 mm

→ Blum Legrabox/Grass Vionaro

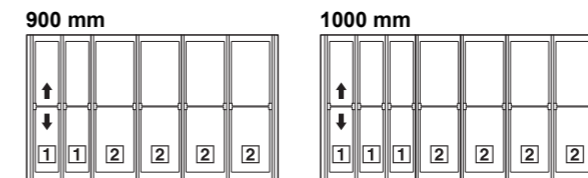
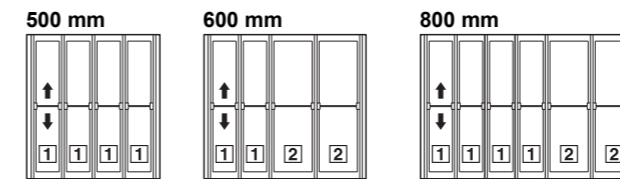

- > Material: Plastic (injection moulded), aluminium
- > Finish: Polished
- > Nom. length: 500 mm
- > Height: 55 mm
- > For internal drawer depth: 473 mm

For cabinet width mm	White translucent	Black translucent
500	550.79.706	550.79.306
600	550.79.707	550.79.307
800	550.79.708	550.79.308
900	550.79.709	550.79.309
1000	550.79.710	550.79.310

Packing: 1 piece

DGH-M 2017, HDE-en,10/16; Dimensional data not binding. We reserve the right to alter specifications without notice.

→ Lateral end panel

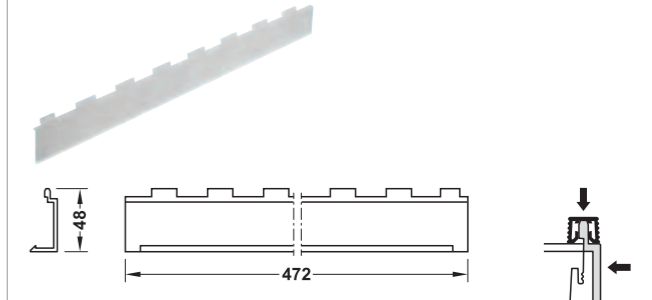

- > Material: Plastic
- > Installation: For plug fitting

Colour	Cat. No.
Black translucent	556.90.491
White translucent	556.90.691

Packing: 1 piece

→ **Matrix Box P/Grass Nova Pro Scala**

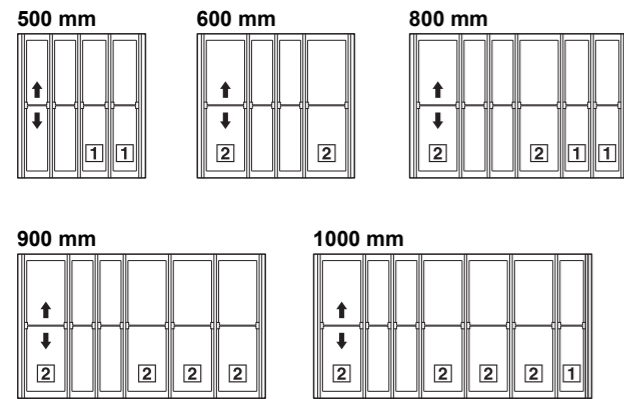

- 1 For knife block for 3 knives
- 2 For knife block for 4 knives

- > Material: Plastic (injection moulded), aluminium
- > Finish: Polished
- > Nom. length: 500 mm
- > Height: 55 mm
- > For internal drawer depth: 480 mm

For cabinet width mm	White translucent	Black translucent
500	553.65.725	553.65.425
600	553.65.727	553.65.427
800	553.65.728	553.65.428
900	553.65.729	553.65.429
1000	553.65.730	553.65.430

Packing: 1 piece

→ **Knife block**

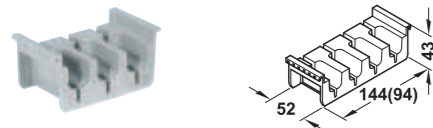

- > Material: Plastic
- > Installation: For plug fitting

	Suitable for	Grey	Black
1	3 knives	556.90.581	556.90.481
2	4 knives	556.90.582	556.90.482

Packing: 1 pair

Food storage container insert

For internal pull outs for door front fixing

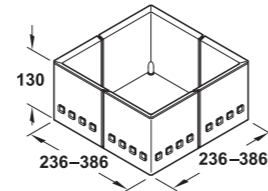

- > Area of application: For subdividing pull outs
- > Material: Plastic (injection moulded)
- > Height: 130 mm
- > Version: With rubber dimples to prevent slipping, width and depth variably adjustable

	3-piece set	4-piece set
Corner: White, middle section: White translucent	556.81.773	556.81.774
Corner: Grey, middle section: White translucent	556.81.573	556.81.574
Corner: Black, middle section: Graphite translucent	556.81.333	556.81.334

Packing: 1 set

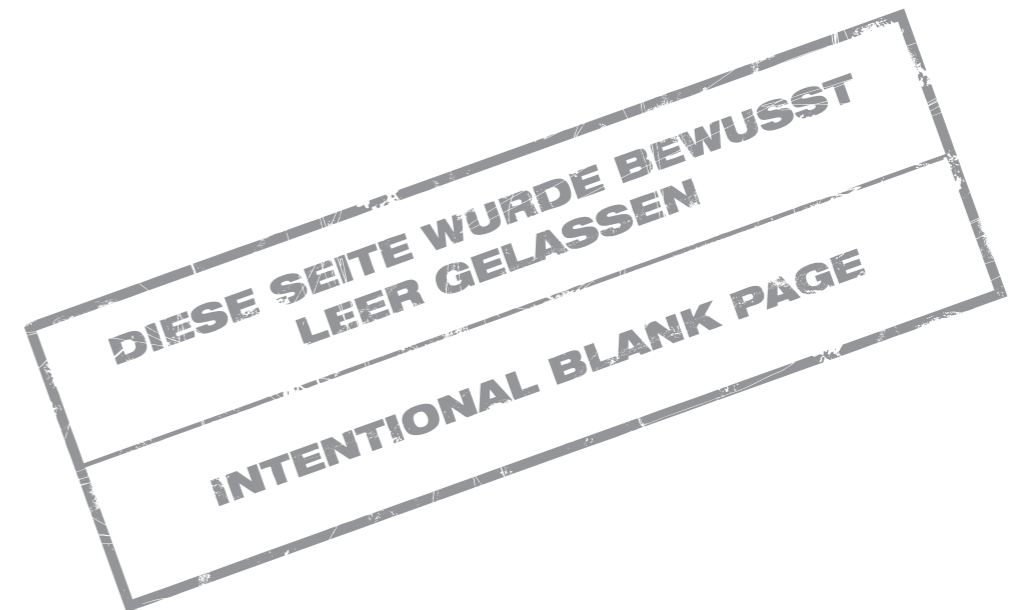

DGH-M 2017, HIDE-en,10/16; Dimensional data not binding. We reserve the right to alter specifications without notice.

Cutlery insert
With wooden inserts

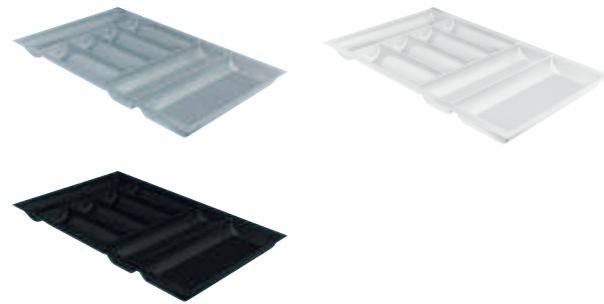

- > Material: Plastic, deep-drawn
- > Colour: White grained, bright silver grey or finely napped black
- > Height: 50 mm
- > Material thickness: Original material: 2.5 mm

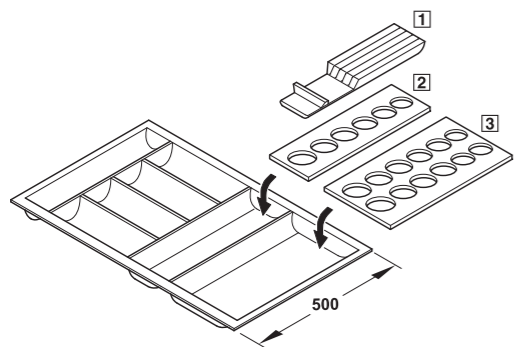

Possible combinations

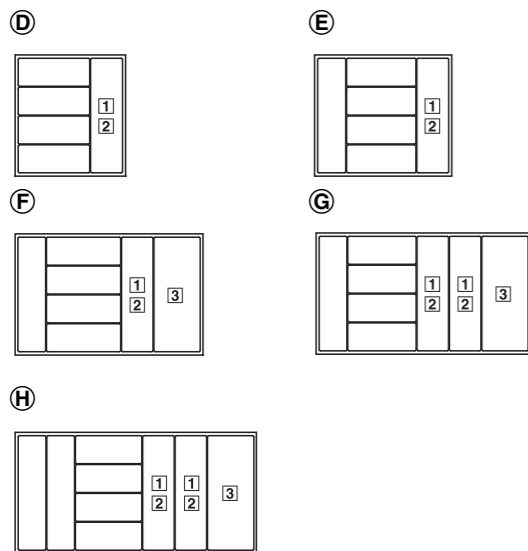

→ **For cutting to own requirements**
Nominal length 500 mm

Compartments overview

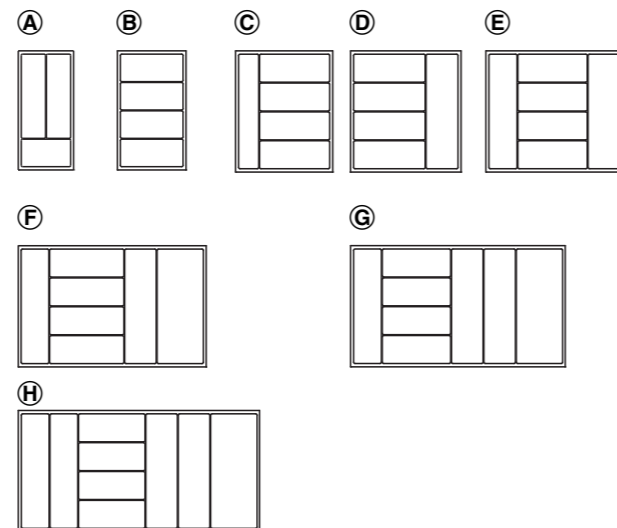

- > Length: Can be shortened, 490–430 mm
- > Nom. length: 500 mm

	For cabinet width mm	Width mm	White grained	Bright silver grey	Finely napped black
A	300	200–240	556.53.730	556.53.530	556.53.930
B	400	300–340	556.53.740	556.53.540	556.53.940
C	450	350–390	556.53.745	556.53.545	556.53.945
D	500	400–440	556.53.750	556.53.550	556.53.950
E	600	500–540	556.53.760	556.53.560	556.53.960
F	800	700–740	556.53.780	556.53.580	556.53.980
G	900	800–840	556.53.790	556.53.590	556.53.990
H	1000	900–940	556.53.800	556.53.600	556.53.000

Packing: 1 piece

DGH-M 2017, HDE-en,10/16; Dimensional data not binding. We reserve the right to alter specifications without notice.

→ **For cutting to own requirements**
Nominal length 550 mm

Compartments overview

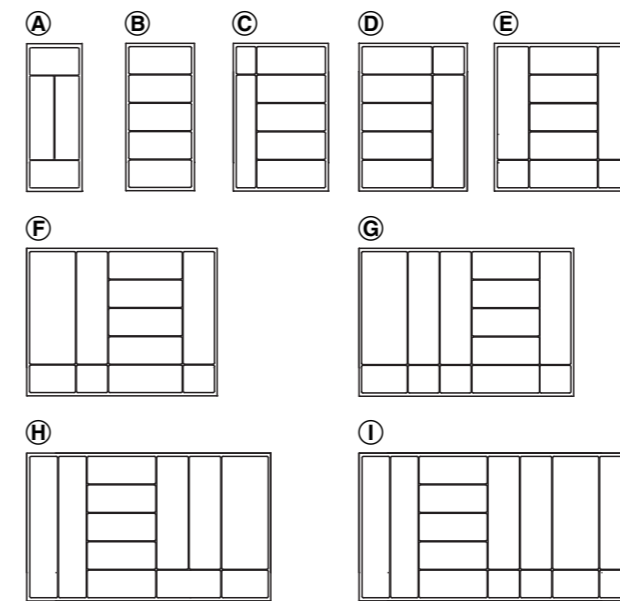

- > Length: Can be shortened, 530–490 mm
- > Nom. length: 550 mm

	For cabinet width mm	Width mm	White grained	Bright silver grey
A	300	200–240	556.53.631	556.53.831
B	400	300–340	556.53.633	556.53.833
C	450	350–390	556.53.634	556.53.834
D	500	400–440	556.53.635	556.53.835
E	600	500–540	556.53.637	556.53.837
F	800	700–740	556.53.639	556.53.839
G	900	800–840	556.53.640	556.53.840
H	1000	900–940	556.53.641	556.53.841
I	1200	1100–1140	556.53.642	556.53.842

Packing: 1 piece

DGH-M 2017, HDE-en,10/16; Dimensional data not binding. We reserve the right to alter specifications without notice.

→ **For cutting to own requirements**
Nennlänge 600 mm

Compartments overview

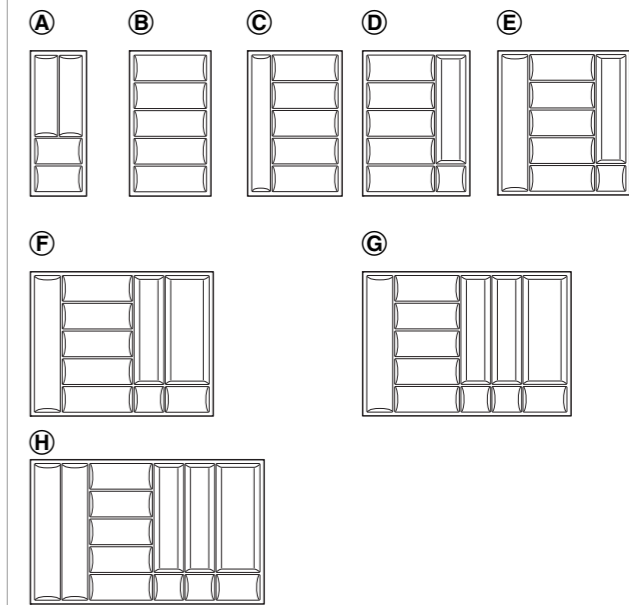

- > Length: Can be shortened, 590–530 mm
- > Nom. length: 600 mm

	For cabinet width mm	Width mm	White grained	Finely napped black
A	300	200–240	556.54.730	556.54.930
B	400	300–340	556.54.740	556.54.940
C	450	350–390	556.54.745	556.54.945
D	500	400–440	556.54.750	556.54.950
E	600	500–540	556.54.760	556.54.960
F	800	700–740	556.54.780	556.54.980
G	900	800–840	556.54.790	556.54.990
H	1000	900–940	556.54.800	556.54.000

Packing: 1 piece

Matrix Box P drawer side runner system	► MB 9.5
Blum drawer side runner system	► MB 9.38
Grass drawer side runner system	► MB 9.117



→ Pre-cut ready for use,
for **Matrix Box P** and **Blum Legrabox**
Nominal length 500 mm

- > Length: 490 mm
- > Nom. length: 500 mm
- > Colour: White grained
- > For side panel thickness: 16 mm

	For cabinet width mm	Häfele Matrix Box P	Blum Legrabox
Ⓐ	300	553.63.741	550.99.701
Ⓑ	400	553.63.743	550.99.703
Ⓒ	450	553.63.744	550.99.704
Ⓓ	500	553.63.745	550.99.705
Ⓔ	600	553.63.747	550.99.707
Ⓕ	800	553.63.748	550.99.708
Ⓖ	900	553.63.749	550.99.709

Packing: 1 piece

→ Pre-cut ready for use,
for **Blum Tandembox** and **Grass Nova Pro**
Nominal length 500 mm

- > Length: 490 mm
- > Nom. length: 500 mm
- > Colour: Bright silver grey
- > For side panel thickness: 16 mm

	For cabinet width mm	Blum Tandembox	Grass Nova Pro Scala
Ⓐ	300	555.20.001	557.70.001
Ⓑ	400	555.20.003	557.70.003
Ⓒ	450	555.20.004	557.70.004
Ⓓ	500	555.20.005	557.70.005
Ⓔ	600	555.20.007	557.70.007
Ⓕ	800	555.20.008	557.70.008
Ⓖ	900	555.20.009	557.70.009

Packing: 1 piece

→ **1** Knife block
Only for nominal length 500 mm

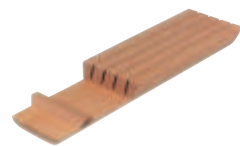

- > Area of application: For cutlery insert from cabinet width 500 mm, for 4 knives
- > Material: Multiplex beech
- > Finish: Lacquered
- > Thickness: 40 mm

	Dim. (L x W) mm	Cat. No.
1 Knife block	414 x 113	556.53.310

Packing: 1 piece

Häfele Matrix Box P drawer side runner system	▶ MB 9.5
Blum drawer side runner system	▶ MB 9.38
Grass drawer side runner system	▶ MB 9.117

DGH-M 2017, HIDE-en,10/16; Dimensional data not binding. We reserve the right to alter specifications without notice.

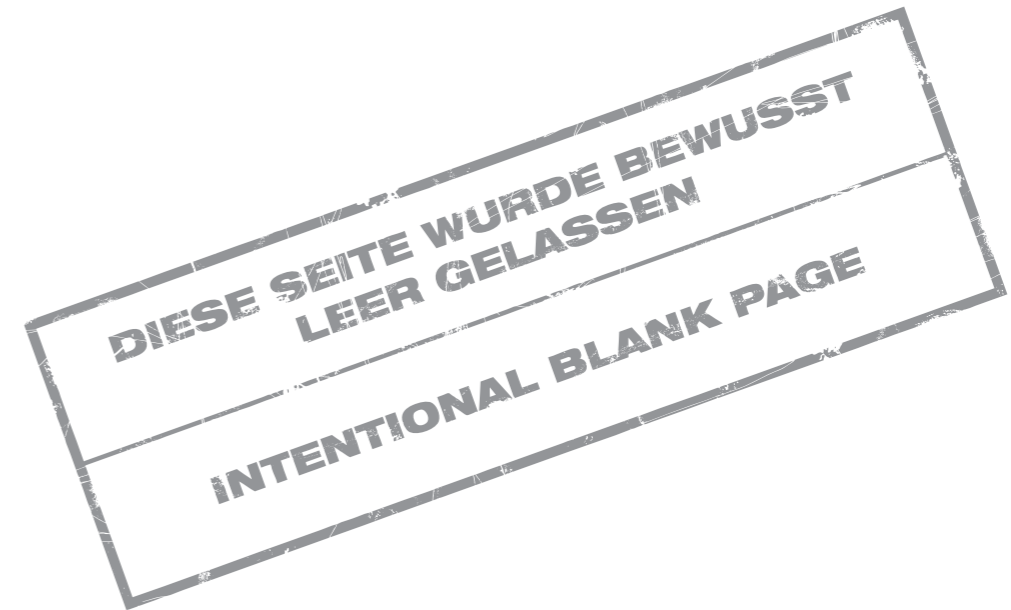

9

Drawer and Pull Out

→ **2 + 3 Spice jar insert**
Only for nominal length of 500 mm

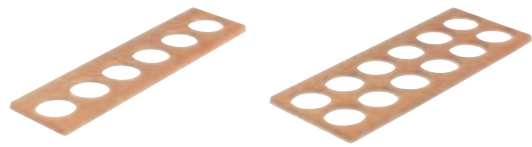

- > Area of application: For cutlery inserts from cabinet width 500 mm (6 spice jars) or 800 mm (12 spice jars)
- > Suitable for: Spice jars Ø 56 mm
- > Material: Multiplex beech
- > Finish: Lacquered
- > Thickness: 10 mm
- > Hole diameter: 61 mm

Suitable for	Dim. (L x W) mm	Cat. No.
2 6 spice jars	417 x 111	556.53.311
3 12 spice jars	417 x 161	556.53.312

Packing: 1 piece

Spice jar set



Stainless steel/acrylic



Stainless steel/plastic

- > Material: Stainless steel
- > Height: Without lid 60 mm, with lid 69 mm, with protective cap 73 mm
- > Diameter: Bottom 50 mm, upper edge 57 mm, lid 60 mm (acrylic lid 64 mm)

	Cat. No.
With acrylic lid and sealing ring	
6-piece set	531.05.016
With stainless steel lid and plastic protective cap	
6-piece set	531.05.006

Packing: 1 piece

Spice jar
With cork lid

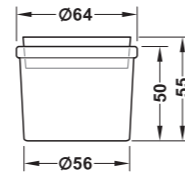

- > Area of application: Suitable for spice jar insert
- > Material: Glass: Lead crystal glass, lid: Cork

	Cat. No.
Lead crystal glass	543.95.110

Packing: 1 piece

→ **Storage container**



Ø 80 x 120 mm

Ø 120 x 160 mm

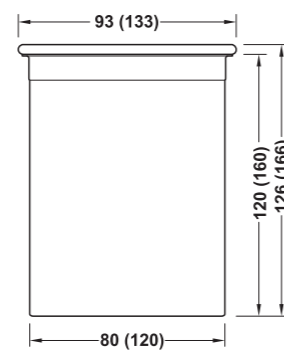

- > Material: Stainless steel, acrylic
- > With suitable lid

Dim. (W x H) mm	Cat. No.
80 x 120	531.05.050
120 x 160	531.05.051

Packing: 1 piece

DGH-M 2017, HDE-en,10/16; Dimensional data not binding. We reserve the right to alter specifications without notice.

Cutlery insert
For cutting to size



Can be accurately and simply cut to size using a circular saw

- > Material: Plastic
- > Material thickness: 2.5 mm

→ **Deep draw**

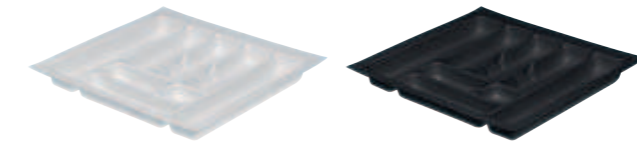

Nominal length 450 mm

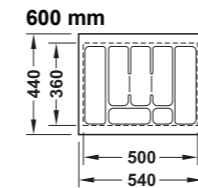
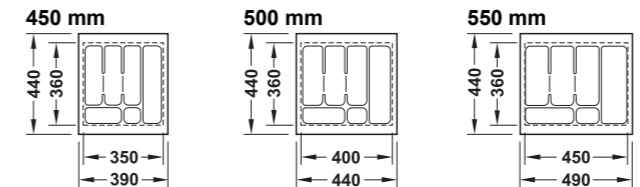

Nominal length 500 mm

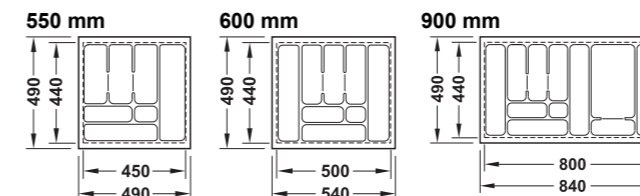
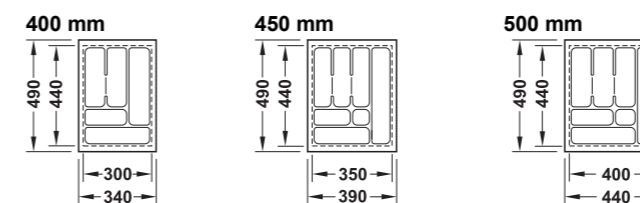

DGH-M 2017, HDE-en,10/16; Dimensional data not binding. We reserve the right to alter specifications without notice.

Nominal length 600 mm

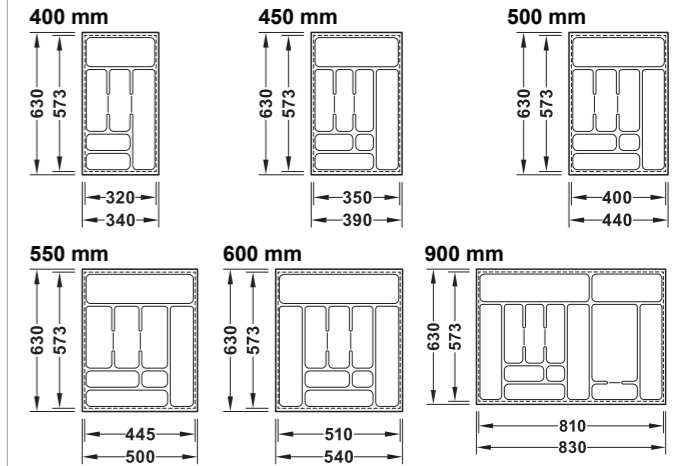

For cabinet width mm	Height mm	White grained	Black finely napped
----------------------	-----------	---------------	---------------------

Nominal length 450 mm			
450	54	556.62.604	556.62.904
500		556.62.605	556.62.905
550		556.62.606	556.62.906
600		556.62.607	556.62.907

Nominal length 500 mm			
400	54	556.62.623	556.62.923
450		556.62.624	556.62.924
500		556.62.625	556.62.925
550		556.62.626	556.62.926
600		556.62.627	556.62.927
900		556.62.630	556.62.930

Nominal length 600 mm			
400	54	556.57.753	556.57.953
450		556.57.754	556.57.954
500		556.57.755	556.57.955
550		556.57.756	556.57.956
600		556.57.757	556.57.957
900		556.57.759	556.57.959

Packing: 1 piece



9

Drawer and Pull Out



9

Drawer and Pull Out

→ Injection moulded

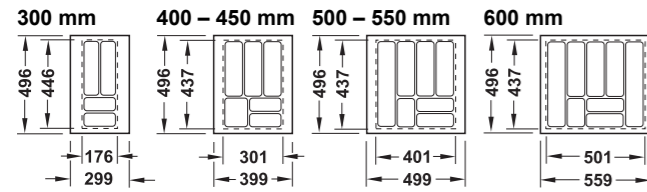
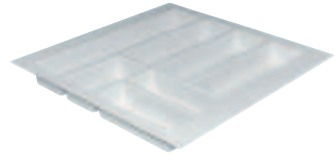

For cabinet width mm	Height mm	White
Nominal length 500 mm		
300	50	556.60.752
400-450		556.60.761
500-550		556.60.770
600		556.60.789

Packing: 1 piece

Order reference

Fixed sizes available on request.

→ Deep drawn

Frame with stainless steel effect provides a modern look



Nominal length 500 mm

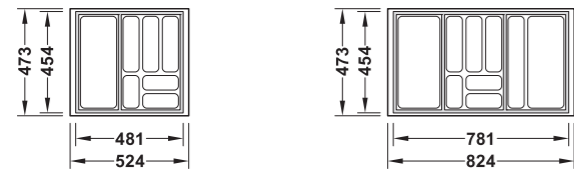

600 mm

900 mm

For cabinet width mm	Height mm	Black
Nominal length 500 mm		
600	53	550.99.327
900	53	550.99.329

Packing: 1 piece

**DIESE SEITE WURDE BEWUSST
LEER GELASSEN**
INTENTIONAL BLANK PAGE

DGH-M 2017, HIDE-en,10/16; Dimensional data not binding. We reserve the right to alter specifications without notice.



9

Drawer and Pull Out

Multi-purpose insert for cutting to size
Deep-drawn

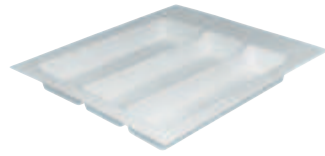

- > Material: Plastic
- > Colour: White grained
- > Nom. length: 500 mm
- > Depth: 430–490 mm
- > Height: 57 mm
- > Material thickness: 2.5 mm
- > Version: With wide rim for cutting to exact drawer size

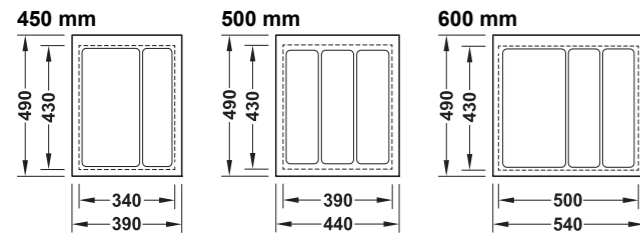

For cabinet width mm	Width mm	Cat. No.
450	340–390	556.65.748
500	390–440	556.65.757
600	500–540	556.65.766

Packing: 1 piece

Special insert
For medical areas



Organisation in the medical area, practices, hospitals and wellness facilities

- > Area of application: For materials and instruments
- > Material: Plastic, deep-drawn
- > Finish/colour: White, high gloss laminated
- > Version: With rim for cutting to drawer size
- > Nom. length: 500 mm

→ **With universal compartments, shallow**

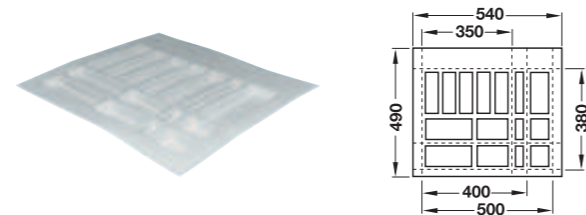

- > Material thickness: 2.5 mm

Height mm	Cat. No.
28	556.66.745

Packing: 1 piece

→ **With instrument compartments, shallow**

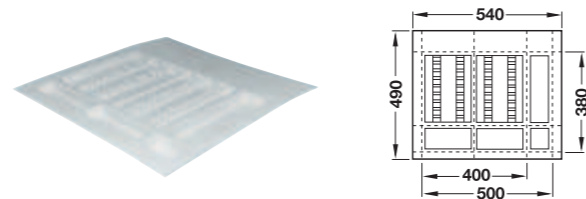

- > Area of application: For dentist's mirrors, tweezers and instruments
- > Material thickness: 2.5 mm

Height mm	Cat. No.
28	556.66.763

Packing: 1 piece

→ **With shallow compartments**

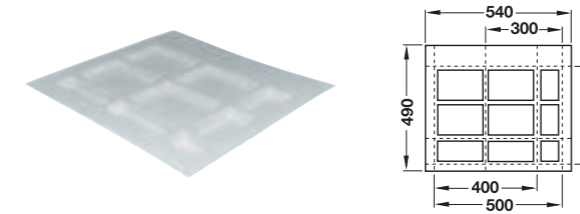

- > Material thickness: 2.5 mm

Height mm	Cat. No.
28	556.66.754

Packing: 1 piece

→ **With 6 compartments, deep**

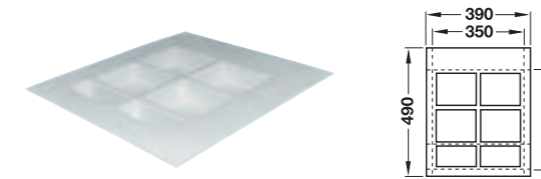

- > Material thickness: 3.5 mm

Height mm	Cat. No.
57	556.66.736

Packing: 1 piece

→ **With small and large compartment, deep**

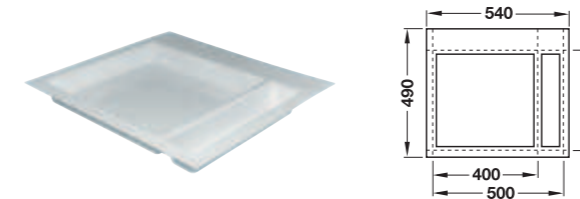

- > Material thickness: 3.5 mm

Height mm	Cat. No.
57	556.66.718

Packing: 1 piece

→ **With deep compartments**

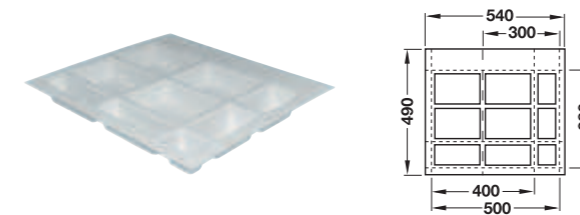

- > Material thickness: 3.5 mm

Height mm	Cat. No.
57	556.66.727

Packing: 1 piece

Cutlery holder assortment

→ **Felt**

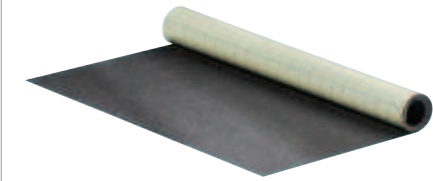

- > Area of application: For lining the bottom of the drawer
- > Version: Self-adhesive, surface cover
- > Thickness: 2 mm

Dim. mm	Wine red	Anthracite	Brown
1000 x 450	891.21.993	891.21.593	891.21.193

Packing: 1 piece

→ **Cutlery holder**

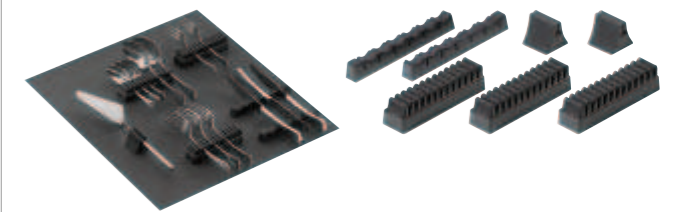

- > Material: Plastic
- > Version: Self-adhesive, with felt covering

Configuration

Assortment	For	
50 pieces	12 knives 12 forks 12 spoons	12 teaspoons 2 large individual items
70 pieces	12 knives 12 forks 12 spoons 12 teaspoons	12 cake forks 6 small individual items 4 large individual items
90 pieces	24 knives 24 forks 12 spoons	12 teaspoons 12 cake forks 6 large individual items

Installation

Glue felt to bottom of drawer before gluing in the cutlery holder assortment.

	Wine red	Anthracite
50 pieces	891.21.911	891.21.511
70 pieces	891.21.920	891.21.520
90 pieces	891.21.939	891.21.539

Packing: 1 set



Häfele Matrix Box P Compartment system
For drawer side height 92 mm



- > Area of application: For subdividing drawers with straight inner drawer sides, such as Matrix Box P, or wooden drawers
- > Colour: White, metallic anthracite or metallic bronze brown

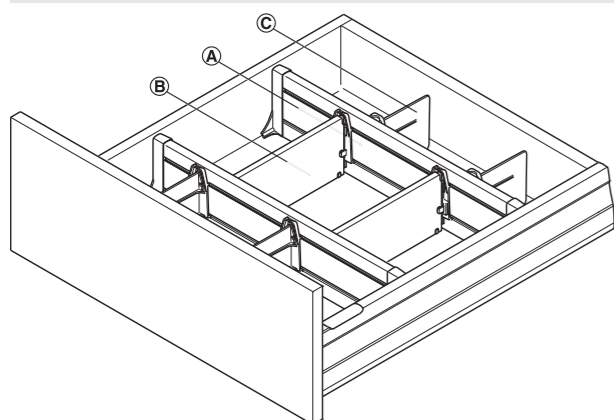

- Ⓐ Crossways divider
- Ⓑ Lengthways divider
- Ⓒ Short divider

Disassembly of lengthways and crossways divider
Lift bracket (1), then pull upwards (2)

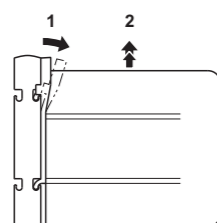

→ Ⓒ Short divider



- > Material: Plastic
- > Installation: For hooking into crossways divider

Dim. (L x H) mm	Colour	Supplied with	Cat. No.
71.5 x 62	Metallic anthracite	4 short dividers	553.73.361
		6 short dividers	553.73.363
		8 short dividers	553.73.367
71.5 x 62	Metallic bronze brown	4 short dividers	553.73.161
		6 short dividers	553.73.163
		8 short dividers	553.73.167

Packing: 1 set

→ Ⓐ Crossways divider

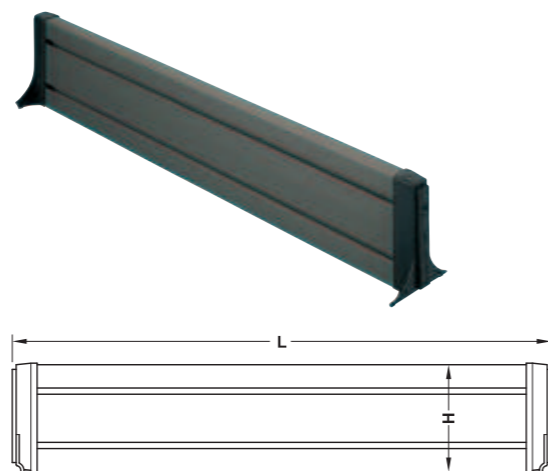

- > Material: Aluminium, tensioning element: Plastic
- > Finish: Anodized, tensioning element: Black
- > Thickness: 12 mm
- > Installation: For tightening in drawers

Colour	For cabinet width mm	Dim. (L x H) mm	2 crossways dividers	3 crossways dividers
White	600	504 x 69	553.73.615	553.73.635
	900	804 x 69	553.73.618	553.73.638
	1200	1104 x 69	553.73.619	553.73.639
Metallic anthracite	600	504 x 69	553.73.415	553.73.435
	900	804 x 69	553.73.418	553.73.438
	1200	1104 x 69	553.73.419	553.73.439
Metallic bronze brown	600	504 x 69	553.73.115	553.73.135
	900	804 x 69	553.73.118	553.73.138
	1200	1104 x 69	553.73.119	553.73.139

Packing: 1 set

→ Ⓑ Lengthways divider

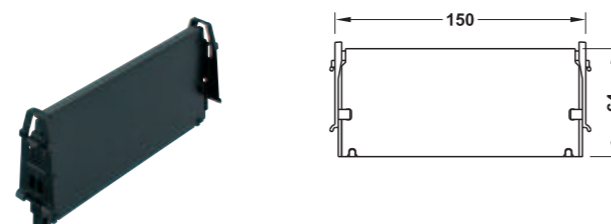

- > Material: Steel
- > Installation: For hooking into crossways divider

Note
Lengthways dividers must always be fixed between 2 crossways dividers.

Dim. (L x H) mm	Colour	Supplied with	Cat. No.
150 x 64	White	2 lengthways dividers	553.73.641
		3 lengthways dividers	553.73.643
		4 lengthways dividers	553.73.647
	Metallic anthracite	2 lengthways dividers	553.73.441
		3 lengthways dividers	553.73.443
		4 lengthways dividers	553.73.447
	Metallic bronze brown	2 lengthways dividers	553.73.141
		3 lengthways dividers	553.73.143
		4 lengthways dividers	553.73.147

Packing: 1 set

DIESE SEITE WURDE BEWUSST
LEER GELASSEN
INTENTIONAL BLANK PAGE

DGH-M 2017, HDE-en,10/16; Dimensional data not binding. We reserve the right to alter specifications without notice.



Cutlery insert, plastic

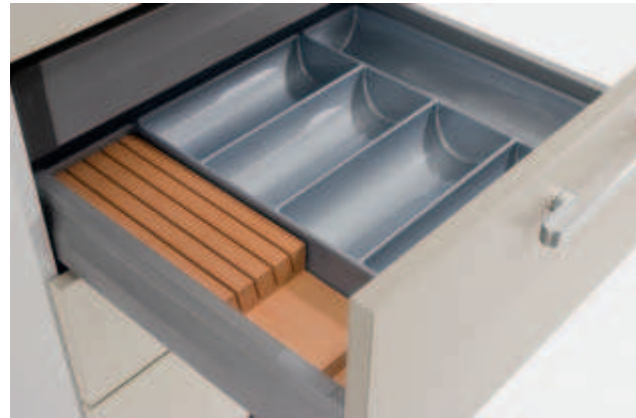

- > Area of application: Can be combined with wooden inserts
- > Material: Plastic
- > Material thickness: Original material: 2.5 mm
- > Version: Deep drawn
- > Nom. length: 500 mm
- > Height: 50 mm

Compartments overview

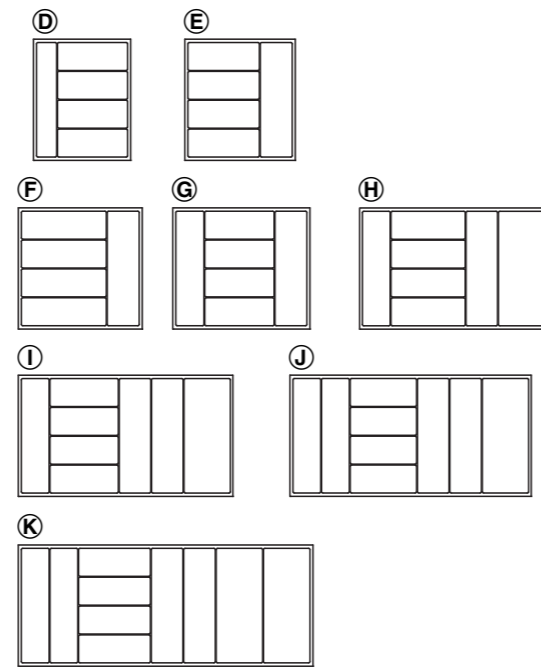

	For cabinet width mm	White	Grey
Side panel thickness 16 mm			
D	450	553.63.744	553.63.244
E	500	553.63.745	553.63.245
F	550	553.63.746	553.63.246
G	600	553.63.747	553.63.247
H	800	553.63.748	553.63.248
I	900	553.63.749	553.63.249
J	1000	553.63.750	553.63.250
K	1200	553.63.751	553.63.251
Side panel thickness 19 mm			
D	450	553.63.764	553.63.264
E	500	553.63.765	553.63.265
F	550	553.63.766	553.63.266
G	600	553.63.767	553.63.267
H	800	553.63.768	553.63.268
I	900	553.63.769	553.63.269
J	1000	553.63.770	553.63.270
K	1200	553.63.771	553.63.271

Packing: 1 piece

Matrix Box P drawer side runner system	► MB 9.5
Knife block	► MB 9.153
Spice jar insert	► MB 9.154

DGH-M 2017, HDE-en,10/16; Dimensional data not binding. We reserve the right to alter specifications without notice.

Drawer insert

Width adjustable, made from wood



Cutlery insert can be continuously adjusted to suit intermediate cabinet widths

- > Area of application: Matrix Box P drawer side runner system
- > Material: Beech or oak/stainless steel
- > Finish: Lacquered
- > Side panel thickness: Optional; connecting strips for drawer sides integrated
- > Version: Width adjustable
- > Nom. length: 500 mm

→ Cutlery insert extension tray, narrow
For cabinet width 300–400 mm

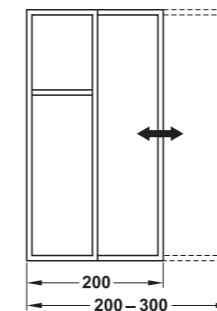

- > Height: 62 mm
- > Width: 200–300 mm
- > Depth: 478

Material	Cat. No.
Beech/stainless steel	553.66.320
Oak/stainless steel	553.66.420

Packing: 1 piece

DGH-M 2017, HDE-en,10/16; Dimensional data not binding. We reserve the right to alter specifications without notice.

→ Cutlery insert extension tray, wide
For cabinet width 450–700 mm

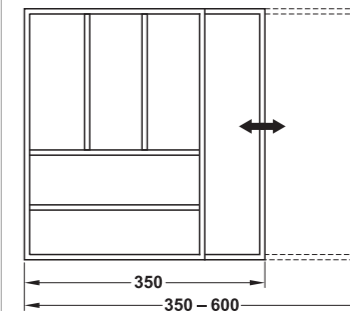

- > Height: 62 mm
- > Width: 350–600 mm
- > Depth: 478

Material	Cat. No.
Beech/stainless steel	553.66.321
Oak/stainless steel	553.66.421

Packing: 1 piece

Matrix Box P drawer side runner system ► MB 9.5

Drawer and Pull Out

Drawer and Pull Out for Door Front Fixing

→ Plate stack drawer insert

For pull out for door front fixing, made from wood



Flexible use of storage space for kitchen equipment, plates and pots

> Area of application: For pull out for door front fixing with Matrix Box P drawer side runner system, for individual configuration of the pull out

→ Divider

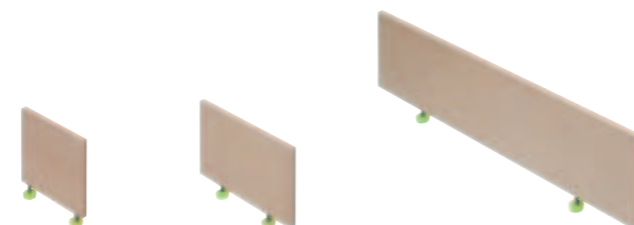

Length 126 mm Length 190 mm Length 480 mm

> Material: Solid beech
> Finish: Lacquered
> Height: 120 mm
> Material thickness: 8 mm
> Installation: For plug fitting and screw fixing to plate stack drawer insert with knurled nuts

Length mm	Cat. No.
126	553.67.321
190	553.67.322
480	553.67.323

Packing: 1 piece

→ Perforated plate base

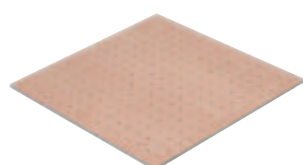

> Material: MDF board, beech veneered
> Finish: Lacquered
> For nominal length: 500 mm
> Depth: 480 mm
> Material thickness: 9 mm
> Installation: Can be cut as required

For cabinet width mm	Width mm	Cat. No.
600	500	553.67.307
800	700	553.67.308
900	800	553.67.309
1000	900	553.67.310

Packing: 1 piece

→ Triangular rack



> Material: Solid beech
> Finish: Lacquered
> Height: 160 mm
> Diameter: 25 mm
> Installation: For plug fitting and screw fixing to plate stack drawer insert with knurled nuts

	Cat. No.
Triangular rack	553.67.390

Packing: 1 piece

Matrix Box P drawer side runner system ▶ MB 9.5





DGH-M 2017, HDE-en,10/16; Dimensional data not binding. We reserve the right to alter specifications without notice.

Plate stack drawer inserts

> Material: MDF 9 mm, birch veneer
> Finish: Lacquered
> Version: 32 mm series drilled holes, with rubber buffer

Note

Inserts can be adapted to suit any commercial pull out up to nominal length of 500 mm.

	Width mm	Depth mm	Height mm	Cat. No.
Plate stack drawer insert for cabinet width 600 mm				
	508	479	9	550.11.301
Plate stack drawer insert for cabinet width 900 mm				
	808	479	9	550.11.302
Plate stack drawer insert for cabinet width 1,200 mm				
	1108	479	9	550.11.303
Plate stack drawer insert for cabinet width 1,200 mm, extra deep				
	1108	650	9	550.11.313

Round rack, 4-piece set



> Height: 160 mm
> Diameter: 25.0 mm
> Installation: For plug fitting and screw fixing to plate stack drawer insert with knurled nut

Version	Cat. No.
4-piece set	550.11.390

Packing: 1 set

Triangular rack



> Material: Solid beech
> Finish: Lacquered
> Height: 160 mm
> Diameter: 25.0 mm
> Installation: For plug fitting and screw fixing to plate stack drawer insert with knurled nut

	Cat. No.
Triangular rack	553.67.390

Packing: 1 piece

DGH-M 2017, HDE-en,10/16; Dimensional data not binding. We reserve the right to alter specifications without notice.







Blum Orga-Line Compartment system for knives, forks and spoons





For system height M, drawer side height 83 mm



- > Material: Stainless steel, side components: Plastic, dust grey, RAL 7037
- > Version: Dishwasher safe
- > For cabinet width: 275–1,200 mm
- > Side panel thickness: 16–19 mm

Note
Illustrations show nominal length 500 mm.

	Nom. length mm	Cat. No.
Cabinet width 275 mm		
	450	555.24.460
	500	555.24.520
	550	555.24.560
	600	555.24.610
	650	555.24.660
Cabinet width from 300 mm to 399 mm		
	450	555.24.330
	500	555.24.340
	550	555.24.350
	600	555.24.360
	650	555.24.370
Cabinet width 400 mm to 549 mm		
	450	555.24.461
	500	555.24.501
	550	555.24.551
	600	555.24.601
	650	555.24.651
Cabinet width 550 mm		
	450	555.24.811
	500	555.24.821
	550	555.24.831
	600	555.24.841
	650	555.24.851
Cabinet width 600 mm		
	450	554.92.071
	500	554.92.072
	550	554.92.073
	600	555.24.842
	650	555.24.852

	Nom. length mm	Cat. No.
Cabinet width 800 mm		
	450	555.24.813
	500	555.24.823
	550	555.24.833
	600	555.24.843
	650	555.24.853
Cabinet width 900 mm		
	450	554.92.091
	500	554.92.092
	550	554.92.093
	600	555.24.844
	650	555.24.854
Cabinet width 1000 mm		
	450	555.24.815
	500	555.24.825
	550	555.24.835
	600	555.24.845
	650	555.24.855
Cabinet width 1200 mm		
	450	554.92.111
	500	554.92.112
	550	554.92.113
	600	555.24.846
	650	555.24.856

Packing: 1 piece

Order reference
Please order drawer separately.

Kitchen gadgets set



- Supplied with**
- 1 Cling film dispenser with cutting blade
 - 1 Aluminium foil dispenser with cutting blade
 - 2 Plate racks
 - 2 Spice racks
 - 1 Knife block

	Model	Cat. No.
Kitchen gadgets set	ZOU.30U11	554.93.011

Packing: 1 set

Drawer, system height M ▶ MB 9.48

DGH-M 2017, HDE-en,10/16; Dimensional data not binding. We reserve the right to alter specifications without notice.





Blum Orga-Line Compartment system for kitchen utensils, knives, small electrical appliances and cleaning utensils

For system height M, drawer side height 83 mm



- > Material: Stainless steel, side components: Plastic, dust grey, RAL 7037
- > Version: Dishwasher safe
- > For cabinet width: 275–1,200 mm
- > Side panel thickness: 16–19 mm

Note
Illustrations show nominal length 500 mm.

	Nom. length mm	Cat. No.
Cabinet width 600 mm		
	450	554.92.471
	500	554.92.472
	550	554.92.473
	600	555.24.942
	650	555.24.952
Cabinet width 800 mm		
	450	555.24.913
	500	555.24.923
	550	555.24.933
	600	555.24.943
	650	555.24.953
Cabinet width 900 mm		
	450	554.92.491
	500	554.92.492
	550	554.92.493
	600	555.24.944
	650	555.24.954
Cabinet width 1000 mm		
	450	555.24.915
	500	555.24.925
	550	555.24.935
	600	555.24.945
	650	555.24.955
Cabinet width 1200 mm		
	450	554.92.511
	500	554.92.512
	550	554.92.513
	600	555.24.946
	650	555.24.956

Packing: 1 piece

Order reference
Please order drawer separately.

DGH-M 2017, HDE-en,10/16; Dimensional data not binding. We reserve the right to alter specifications without notice.

→ Knife block

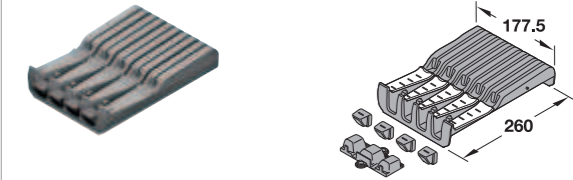

Material	Colour	Model	Cat. No.
Plastic	Dust grey, RAL 7037	ZSZ.02M0	555.24.010

Packing: 1 piece

Note
Knife block suitable for cabinet width of 400 mm and above; Can be inserted into the compartment system (optional).

→ Foil dispenser

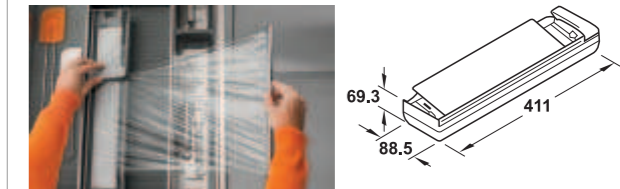

- > Material: Steel
- > Version: With inserted foil

Area of application	Model	Cat. No.
For cling film	ZSZ.01F0	554.93.000
For aluminium foil	ZSZ.02F0	554.93.001

Packing: 1 piece

Note
The foil dispenser with cutting blade can be inserted into the compartment system (optional).

Drawer, system height M ▶ MB 9.48



9

Drawer and Pull Out



9

Drawer and Pull Out

Blum Orga-Line Compartment system, special version with trays and compartments

For system height M, drawer side height 83 mm



- > Material: Stainless steel, side components: Plastic, dust grey, RAL 7037
- > Version: Dishwasher safe
- > For nominal length: 450–650 mm; not corner unit

Note
Illustrations show nominal length 500 mm

	Nom. length mm	Model	Cat. No.
Cutlery sets			
	450	ZSI.450BI1N	555.24.460
	500	ZSI.500BI1N	555.24.520
	550	ZSI.550BI1N	555.24.560
	600	ZSI.600BI1N	555.24.610
	650	ZSI.650BI1N	555.24.660
	450	ZSI.450BI2N	555.24.330
	500	ZSI.500BI2N	555.24.340
	550	ZSI.550BI2N	555.24.350
	600	ZSI.600BI2N	555.24.360
	650	ZSI.650BI2N	555.24.370
Compartment sets			
	450	ZSI.450FI2N	555.24.331
	500	ZSI.500FI2N	555.24.341
	550	ZSI.550FI2N	555.24.351
	600	ZSI.600FI2N	555.24.361
	650	ZSI.650FI2N	555.24.371
	450	ZSI.450FI3	555.24.454
	500	ZSI.500FI3	555.24.504
	550	ZSI.550FI3	555.24.554
	600	ZSI.600FI3	555.24.604
	650	ZSI.650FI3	555.24.654

	Nom. length mm	Model	Cat. No.
Combi sets			
	450	ZSI.450KI2N	555.24.465
	500	ZSI.500KI2N	555.24.515
	550	ZSI.550KI2N	555.24.565
	600	ZSI.600KI2N	555.24.615
	650	ZSI.650KI2N	555.24.665
	450	ZSI.450KI3N	555.24.332
	500	ZSI.500KI3N	555.24.342
	550	ZSI.550KI3N	555.24.352
	600	ZSI.600KI3N	555.24.362
	650	ZSI.650KI3N	555.24.372
	450	ZSI.450KI4N	555.24.467
	500	ZSI.500KI4	555.24.507
	550	ZSI.550KI4	555.24.557
	600	ZSI.600KI4	555.24.607
	650	ZSI.650KI4	555.24.657

Packing: 1 piece

Order reference
Please order drawer separately.

→ **Tray**

	Dim. (W x D) mm	Model	Cat. No.
	88 x 88	ZSI.010SI	555.24.001
	88 x 176	ZSI.020SI	555.24.002
	88 x 264	ZSI.030SI	555.24.003
	88 x 352	ZSI.040SI	555.24.004

Packing: 1 piece

→ **Crossways divider**

	Length mm	Model	Cat. No.
	88	ZSI.010Q	555.24.091
	176	ZSI.020Q	555.24.092

Packing: 1 piece

Planning dimensions ▶ MB 9.38
Drawer, system height M ▶ MB 9.48

DGH-M 2017, HDE-en,10/16; Dimensional data not binding. We reserve the right to alter specifications without notice.

Blum Orga-Line Compartment system with cross railing

For Tandembox antaro, system height M, drawer side height 83 mm with railing C and D
For Tandembox antaro, system height K, drawer side height 115 mm with railing D



→ **Cross railing (J)**

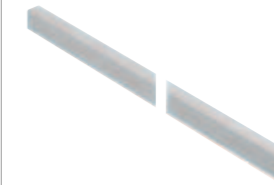

- > Area of application: For Tandembox antaro drawer side runner system
- > Material: Aluminium
- > Model: ZRG.1104Q
- > Version: Can be shortened
- > Length: 1,104 mm
- > For cabinet width: Max. 1,200 mm
- > Installation: For clipping into cross railing holder (V), cross railing must be cut to size, length = internal cabinet width – 63 mm

Finish/colour	Cat. No.
Silk white	553.94.710
Terra black	553.94.310
White aluminium, RAL 9006	553.94.210

Packing: 1 piece

→ **Cross railing holder (V)**



- > Material: Plastic
- > Installation: For clipping into railing C and D
- > Model: ZRU.01EO

Colour	Cat. No.
Silk white	553.94.792
Black	553.94.392
White grey	553.94.692

Packing: 1 or 80 pieces

Order reference
Please order cross railing (J) for cutting to size separately.

→ **Lengthways divider (W)**



- > Area of application: For Tandembox antaro drawer side runner system
- > Material: Plastic
- > Model: ZRU.11F0
- > Length: 87 mm
- > Installation: For clipping into cross railing (J)

Colour	Cat. No.
Silk white	553.94.780
Black	553.94.380
White grey	553.94.680

Packing: 1 piece

Subdivision with cross railing

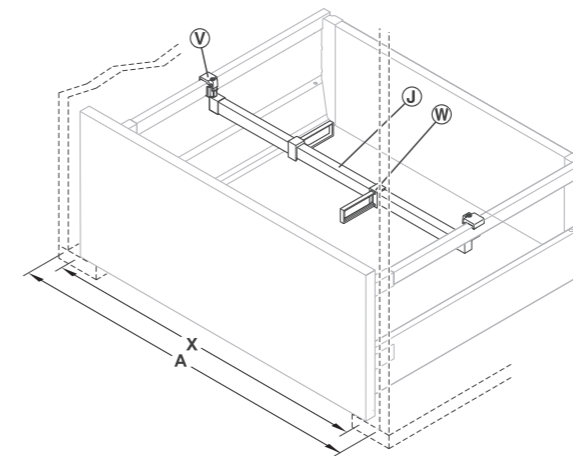

- (J) Cross railing
- (V) Cross railing holder
- (W) Lengthways divider

A = internal cabinet width
X = internal cabinet width – 91 mm

Suggested configuration

For nominal length mm	
270–450	500–650
1 cross railing (J)	2 cross railing (J)
2 cross railing holders (V)	4 cross railing holders (V)
2 lengthways dividers (W)	4 lengthways dividers (W)

DGH-M 2017, HDE-en,10/16; Dimensional data not binding. We reserve the right to alter specifications without notice.

Blum Orga-Line Compartment system with crossways divider

For Tandembox antaro, system height M, drawer side height 83 mm with railing C and D
For Tandembox antaro, system height K, drawer side height 115 mm with railing D

- > Area of application: For pots and pans, storage and plastic containers in internal pull out for door front fixing, for bottle tray: For bottles, cleaning agents, recyclable material and chopping boards in pull out for door front fixing
- > For nominal length: Crossways divider: 270–650 mm, bottle tray and intermediate panel: 450–650 mm
- > For cabinet width: 275–1,200 mm, bottle tray: 300 mm, bottle tray with intermediate panel: 400–1,200 mm



Compartments with crossways dividers and bottle tray

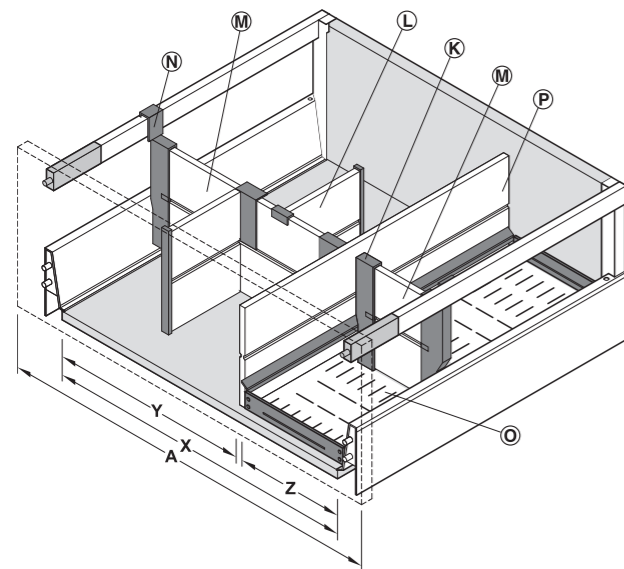

- Ⓚ Crossways divider holder set for intermediate panel
- Ⓛ Lengthways divider
- Ⓜ Crossways divider
- Ⓝ Crossways divider holder set
- Ⓞ Bottle tray
- Ⓟ Intermediate panel

A = internal cabinet width
X = internal cabinet width – 91 mm
Y = internal cabinet width – 295 mm (for cabinet width 275 mm),
internal cabinet width – 320 mm (for cabinet width 300 mm)
Z = 177 mm

Order reference
An intermediate panel Ⓟ is required for a cabinet width of 400 mm and above, please order separately.

→ **Crossways divider holder set for intermediate panel Ⓚ**



- > Material: Plastic
- > Model: Z40L0002
- > Installation: For clipping into intermediate panel Ⓟ

Colour	Cat. No.
Silk white	553.95.790
Terra black	553.95.390
White grey	553.95.690

Packing: 2 pieces

→ **Crossways divider holder set Ⓝ**

For Tandembox antaro drawer side runner system, system height M with railing C



- > Material: Plastic
- > Model: Z40C0002Z
- > Installation: For clipping into railing C

Colour	Cat. No.
Silk white	553.89.794
Terra black	553.89.394
White grey	553.89.694

Packing: 1 piece

For Tandembox antaro drawer side runner system, system height M and K with railing D



- > Material: Plastic
- > Model: Z40D0002Z
- > Installation: For clipping into railing D

Colour	Cat. No.
Silk white	553.89.795
Terra black	553.89.395
White grey	553.89.695

Packing: 1 piece

DGH-M 2017, HDE-en,10/16; Dimensional data not binding. We reserve the right to alter specifications without notice.

→ **Lengthways divider Ⓛ**



- > Area of application: For Tandembox antaro drawer side runner system
- > Length: 100 mm
- > Installation: For clipping into crossways divider Ⓜ

Material	Model	Colour	Cat. No.
Steel	Z43L100S	Silk white	553.95.780
		Terra black	553.95.380
		White aluminium, RAL 9006	553.95.280

Packing: 1 piece

→ **Intermediate panel Ⓟ**



- > Area of application: For Tandembox antaro drawer side runner system
- > Height: 151 mm
- > Installation: For screw fixing to base panel

Note
Not suitable for internal pull out.

Nom. length mm	Model	Steel		
		silk white	terra black	white aluminium, RAL 9006
450	Z46L420S	553.95.754	553.95.354	553.95.254
500	Z46L470S	553.95.755	553.95.355	553.95.255
550	Z46L520S	553.95.756	553.95.356	553.95.256
600	Z46L570S	553.95.757	553.95.357	553.95.257
650	Z46L620S	553.95.758	553.95.358	553.95.258

Packing: 1 piece

DGH-M 2017, HDE-en,10/16; Dimensional data not binding. We reserve the right to alter specifications without notice.

→ **Crossways divider Ⓜ, can be cut to size**



- > Area of application: For Tandembox antaro drawer side runner system
- > Material: Aluminium
- > Model: Z40L1077A
- > Version: Can be shortened
- > Length: 1,077 mm
- > For cabinet width: Max. 1,200 mm
- > Installation: For clipping into crossways divider holder Ⓝ
- > Cut: When used

Finish/colour	Cat. No.
Silk white	553.96.719
Terra black	553.96.319
Dust grey, RAL 7037	553.96.219

Packing: 1 piece

Order reference
Please order 1 crossways divider holder set Ⓝ for each crossways divider.

→ **Bottle tray Ⓞ**

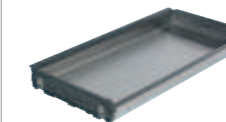

- > Area of application: For Tandembox antaro drawer side runner system
- > Material: Stainless steel
- > Version: Dishwasher safe
- > For cabinet width: 300 mm, with intermediate panel 400–1,200 mm
- > Installation: For placing into drawers

Nom. length mm	Model	Cat. No.
450	Z48.30B014	554.91.053
500	Z48.30B016	554.91.055
550	Z48.30B017	554.91.056
600	Z48.30B018	554.91.057
650	Z48.30B019	554.91.058

Packing: 1 piece

Order reference
An intermediate panel Ⓟ is required for a cabinet width of 400 mm and above. Please order separately.



Cutlery insert
Made from wood



Cutlery insert can be continuously adjusted to suit intermediate cabinet widths.

- > Area of application: For drawer side runner system made from wood and metal with min. system height 65 mm
- > Finish: Lacquered
- > Side panel thickness: Optional, connecting strips for drawer sides integrated
- > Version: Can be extended to the left or right using further inserts

Note
Effective usable width of the inside of the pull out for door front fixing:
External cabinet width – 100 mm.

Order reference
Maple, oak and walnut are not stocked, please note corresponding delivery time.
Inserts for nominal lengths 300, 400 and 450 mm available on request.

Drawer insert

→ **Knife block**

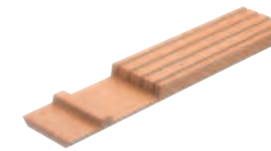

- > Width: 100 mm
- > Height: 32 mm
- > Depth: Nominal length – 28 mm
- > Version: With handle storage area, for 4 knives

For nominal length mm	Beech	Oak
500	555.38.341	555.38.441
550	555.38.344	555.38.444
600	555.38.345	555.38.445
650	555.38.346	555.38.446

Packing: 1 piece

→ **Spice rack**



- > Width: 100 mm
- > Height: 32 mm
- > Depth: Nominal length – 28 mm
- > Version: For 6 spice jars (nominal length: 500 mm) and 8 spice jars (nominal length: from 550 mm) with max. length 150 mm, Ø 48 mm

For nominal length mm	Beech	Oak
500	555.37.320	555.37.420
550	555.37.321	555.37.421
600	555.37.322	555.37.422
650	555.37.323	555.37.423

Packing: 1 piece



→ Width adjustable for cabinet widths of 300–400 mm

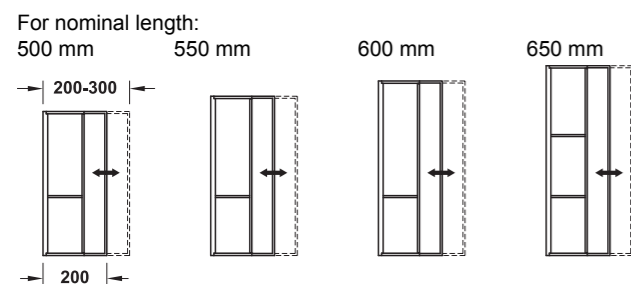
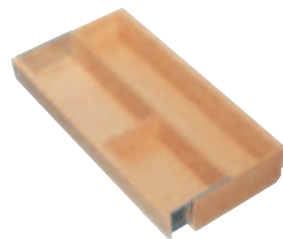

- > Width: 200–300 mm
- > Height: 62 mm
- > Depth: Nominal length – 28 mm

For nominal length mm	Beech	Oak
500	555.38.350	555.38.450
550	555.38.352	555.38.452
600	555.38.354	555.38.454
650	555.38.356	555.38.456

Packing: 1 piece

→ Width adjustable for cabinet widths of 450–700 mm

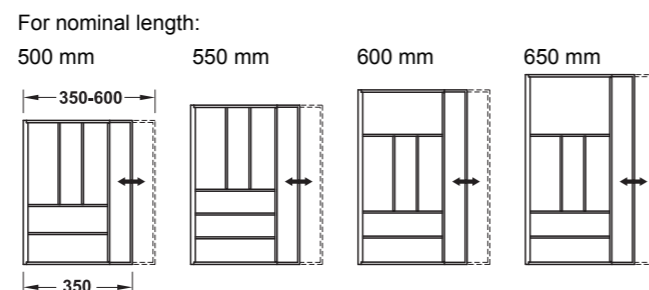
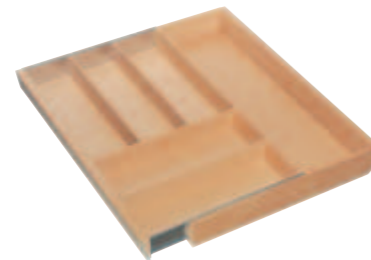

- > Width: 350–600 mm
- > Height: 62 mm
- > Depth: Nominal length – 28 mm

For nominal length mm	Beech	Oak
500	555.38.351	555.38.451
550	555.38.353	555.38.453
600	555.38.355	555.38.455
650	555.38.357	555.38.457

Packing: 1 piece

Blum Tandembox drawer side runner system ▶ MB 9.38

DGH-M 2017, HDE-en,10/16; Dimensional data not binding. We reserve the right to alter specifications without notice.



9

Drawer and Pull Out

DGH-M 2017, HDE-en,10/16; Dimensional data not binding. We reserve the right to alter specifications without notice.

17.08.2020
ID 5299

17.08.2020
ID 5299



Ambia Line

Ambia Line steel design

Colour options



Matt silk white, insert of cutlery insert
matt Orion grey
**Matching the drawer side colour
(Blum Legrabox)**
> Matt silk white



Matt Orion grey
**Matching the drawer side colour
(Blum Legrabox)**
> Matt Orion grey



Matt terra black
**Matching the drawer side colour
(Blum Legrabox)**
> Matt terra black
> Stainless steel

Cutlery insert

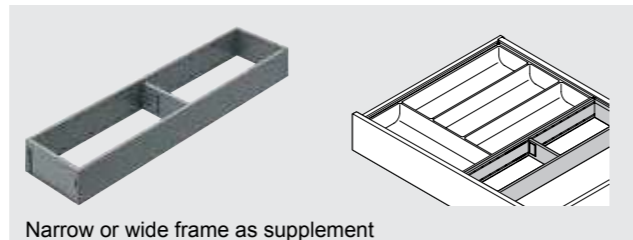
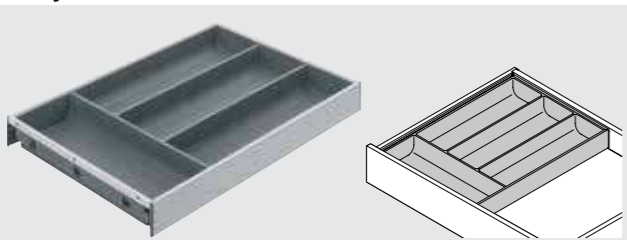

Narrow or wide frame as supplement

Ambia Line wood design

Colour options



Frame: Bardolino oak,
steel components: Matt silk white
**Matching the drawer side colour
(Blum Legrabox)**
> Matt silk white



Frame: Nebraska oak,
steel components: Matt Orion grey
**Matching the drawer side colour
(Blum Legrabox)**
> Matt Orion grey



Frame: Tennessee walnut,
steel components: Matt terra black
**Matching the drawer side colour
(Blum Legrabox)**
> Matt terra black
> Stainless steel

Cutlery insert

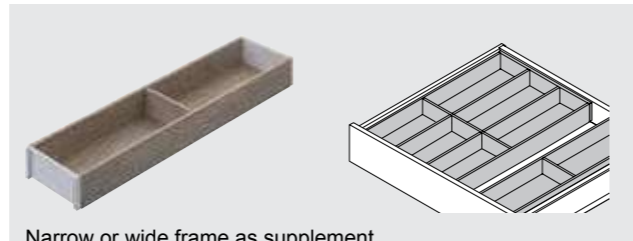
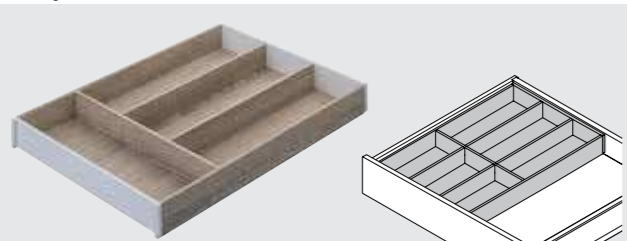

Narrow or wide frame as supplement

Note: Further versions and accessories can be found online at www.com.

DGH-M 2017, HDE-en, 10/16; Dimensional data not binding. We reserve the right to alter specifications without notice.

Cutlery insert

For drawer sides with system height M and K

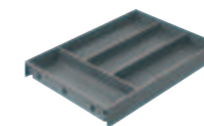

For drawer sides with nominal
length of 450 mm

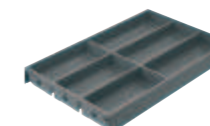

For drawer sides with nominal
length of 500 mm

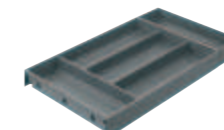

For drawer sides with nominal
length of 550 mm

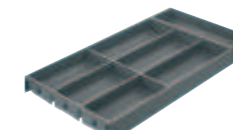

For drawer sides with nominal
length of 600 mm

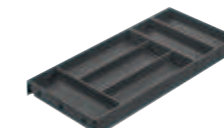

For drawer sides with nominal
length of 650 mm

- > Version: With Softtouch finish
- > Material: Plastic
- > Width: 300 mm
- > Model: ZC7S450(500/550/600/650)BS3

For nominal length mm	Finish	Cat. No.
450	Insert and frame Orion grey, matt	550.80.503
	Insert Orion grey, matt, frame silk white, matt	550.80.703
	Insert and frame terra black, matt	550.80.303
500	Insert and frame Orion grey, matt	550.80.504
	Insert Orion grey, matt, frame silk white, matt	550.80.704
	Insert and frame terra black, matt	550.80.304
550	Insert and frame Orion grey, matt	550.80.505
	Insert Orion grey, matt, frame silk white, matt	550.80.705
	Insert and frame terra black, matt	550.80.305
600	Insert and frame Orion grey, matt	550.80.506
	Insert Orion grey, matt, frame silk white, matt	550.80.706
	Insert and frame terra black, matt	550.80.306
650	Insert and frame Orion grey, matt	550.80.507
	Insert Orion grey, matt, frame silk white, matt	550.80.707
	Insert and frame terra black, matt	550.80.307

Packing: 1 piece

DGH-M 2017, HDE-en, 10/16; Dimensional data not binding. We reserve the right to alter specifications without notice.

Cutlery insert

For drawer sides with system height M and K

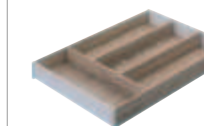

For drawer sides with nominal
length of 450 mm

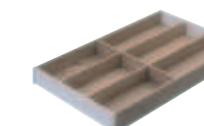

For drawer sides with nominal
length of 550 mm

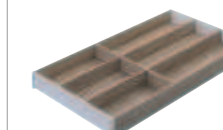

For drawer sides with nominal
length of 500 mm

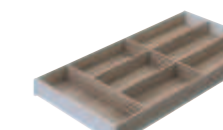

For drawer sides with nominal
length of 600 mm

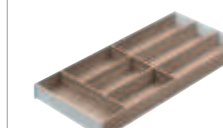

For drawer sides with nominal
length of 650 mm

- > Material: Wood effect/steel
- > Width: 300 mm
- > Model: ZC7S450(500/550/600/650)BH3

For nominal length mm	Finish	Cat. No.
450	Frame Bardolino oak, steel components silk white	550.80.403
	Frame Nebraska oak, steel components Orion grey	550.80.803
	Frame Tennessee nut tree, steel components terra black	550.80.603
500	Frame Bardolino oak, steel components silk white	550.80.404
	Frame Nebraska oak, steel components Orion grey	550.80.804
	Frame Tennessee nut tree, steel components terra black	550.80.604
550	Frame Bardolino oak, steel components silk white	550.80.405
	Frame Nebraska oak, steel components Orion grey	550.80.805
	Frame Tennessee nut tree, steel components terra black	550.80.605
600	Frame Bardolino oak, steel components silk white	550.80.406
	Frame Nebraska oak, steel components Orion grey	550.80.806
	Frame Tennessee nut tree, steel components terra black	550.80.606
650	Frame Bardolino oak, steel components silk white	550.80.407
	Frame Nebraska oak, steel components Orion grey	550.80.807
	Frame Tennessee nut tree, steel components terra black	550.80.607

Packing: 1 piece

Blum Legrabox drawer side runner system ▶ MB 9.72



Narrow frame

For drawer sides with system height M and K
(height 50 mm)

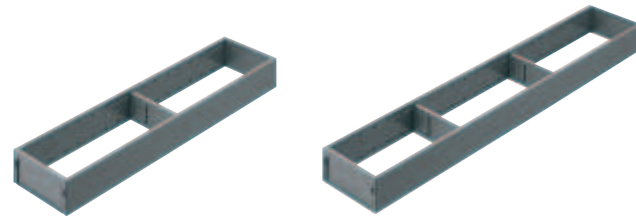

Nominal length 450–550 mm (1 crossways divider) Nominal length 600–650 mm (2 crossways dividers)

- > Version: For inserting in drawers, without base
- > Material: Steel, crossways divider: Plastic
- > Width: 100 mm
- > Model: ZC7S450(500/550/600/650)RS1

	For nominal length mm	Finish	Cat. No.
1 crossways divider	From 450	Orion grey, matt	550.81.503
		Silk white, matt	550.81.703
		Terra black, matt	550.81.303
	From 500	Orion grey, matt	550.81.504
		Silk white, matt	550.81.704
		Terra black, matt	550.81.304
	From 550	Orion grey, matt	550.81.505
		Silk white, matt	550.81.705
		Terra black, matt	550.81.305
2 crossways dividers	From 600	Orion grey, matt	550.81.506
		Silk white, matt	550.81.706
		Terra black, matt	550.81.306
	From 650	Orion grey, matt	550.81.507
		Silk white, matt	550.81.707
		Terra black, matt	550.81.307

Packing: 1 piece

→ **Bottle holder set for narrow frame**

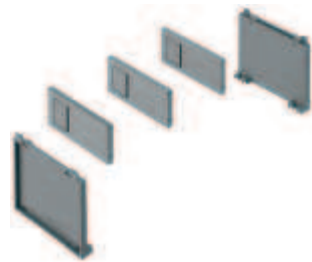

- > Version: For increasing the height and inserting into the frame

Supplied with
3 crossways dividers
2 frame height extensions

Finish	Cat. No.
Orion grey, matt	550.80.540
Silk white, matt	550.80.740
Terra black, matt	550.80.340

Packing: 1 piece

Order reference
Please order narrow frame separately.

Wide frame

For drawer sides with system height M and K
(height 50 mm)

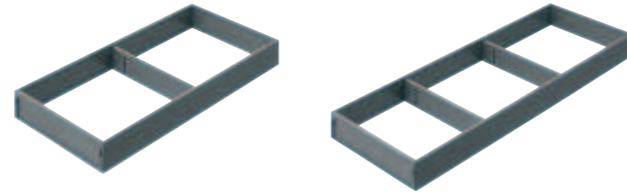

Nominal length 450–550 mm (2 crossways dividers) Nominal length 600–650 mm (2 crossways dividers)

- > Version: For inserting in drawers, without base
- > Material: Steel, crossways divider: Plastic
- > Width: 200 mm
- > Model: ZC7S450(500/550/600/650)RS2

Quantity	For nominal length mm	Finish	Cat. No.
1 crossways divider	From 450	Orion grey, matt	550.81.513
		Silk white, matt	550.81.713
		Terra black, matt	550.81.313
	From 500	Orion grey, matt	550.81.514
		Silk white, matt	550.81.714
		Terra black, matt	550.81.314
	From 550	Orion grey, matt	550.81.515
		Silk white, matt	550.81.715
		Terra black, matt	550.81.315
2 crossways dividers	From 600	Orion grey, matt	550.81.516
		Silk white, matt	550.81.716
		Terra black, matt	550.81.316
	From 650	Orion grey, matt	550.81.517
		Silk white, matt	550.81.717
		Terra black, matt	550.81.317

Packing: 1 piece

→ **Bottle holder set for wide frame**

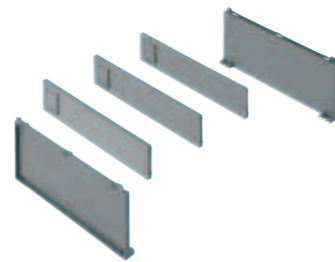

- > Version: For increasing the height and inserting into the frame

Supplied with
3 crossways dividers
2 frame height extensions

Finish	Cat. No.
Orion grey, matt	550.80.550
Silk white, matt	550.80.750
Terra black, matt	550.80.350

Packing: 1 piece

Order reference
Please order wide frame separately.

DGH-M 2017, HDE-en,10/16; Dimensional data not binding. We reserve the right to alter specifications without notice.

Frame

For drawer sides with system height M or K
(height 50 mm)

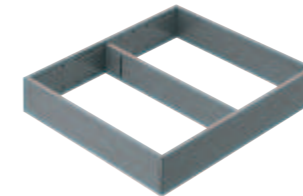

- > Version: With magnet for connection to drawer side or adapter, with 1 adjustable crossways divider, without base
- > Material: Steel, crossways divider plastic
- > Model: ZC7S300RSU

For nominal length mm	Width mm	Finish	Cat. No.
From 270	242	Orion grey, matt	550.81.531
		Silk white, matt	550.81.731
		Terra black, matt	550.81.331

Packing: 1 piece

→ **Crossways divider for frame**

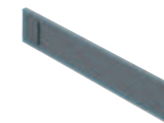

- > Area of application: For further subdivision of frames
- > Material: Plastic
- > Width: 230 mm
- > Height: 50 mm
- > Model: ZC7Q0U0SS
- > Installation: For clip fixing

Finish	Cat. No.
Orion grey, matt	550.81.588
Silk white, matt	550.81.788
Terra black, matt	550.81.388

Packing: 1 piece

DGH-M 2017, HDE-en,10/16; Dimensional data not binding. We reserve the right to alter specifications without notice.

Frame

For drawer sides with system height C or F
(height 110 mm)



- > Version: With magnet for connection to drawer side or adapter, with 1 adjustable crossways divider, without base
- > Material: Steel, crossways divider: Plastic
- > Model: ZC7F300RSU(400RSP)

For nominal length mm	Width mm	Finish	Cat. No.
From 270	242	Orion grey, matt	550.81.541
		Silk white, matt	550.81.741
		Terra black, matt	550.81.341
From 400	218	Orion grey, matt	550.81.522
		Silk white, matt	550.81.722
		Terra black, matt	550.81.322

Packing: 1 piece

→ **Crossways divider for frame**

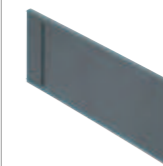

- > Area of application: For further subdivision of frames
- > Material: Plastic
- > Height: 110 mm
- > Installation: For clip fixing
- > Model: ZC7Q0U(P)0FS

Finish	Cat. No.
For frame with width of 218 mm	
Orion grey, matt	550.81.579
Silk white, matt	550.81.779
Terra black, matt	550.81.379
For frame with width of 242 mm	
Orion grey, matt	550.81.589
Silk white, matt	550.81.789
Terra black, matt	550.81.389

Packing: 1 piece

Blum Legrabox drawer side runner system ▶ MB 9.72



Narrow frame

For drawer sides with system height M and K
(height 50 mm)

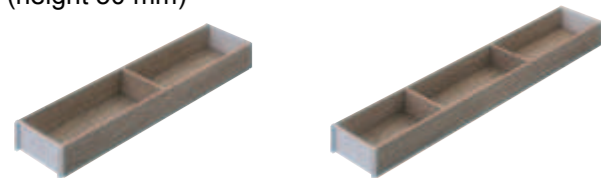

Nominal length 450–550 mm
(1 crossways divider)

Nominal length 600 mm
(2 crossways dividers)

- > Version: For inserting in drawers, with base
- > Material: Wood decor/steel
- > Width: 100 mm
- > Model: ZC7S450(500/550/600)RH1

	For nominal length mm	Finish	Cat. No.
1 cross-ways divider	From 450	Frame Bardolino oak, steel components silk white	550.81.403
		Frame Nebraska oak, steel components Orion grey	550.81.803
		Frame Tennessee nut tree, steel components terra black	550.81.603
	From 500	Frame Bardolino oak, steel components silk white	550.81.404
		Frame Nebraska oak, steel components Orion grey	550.81.804
		Frame Tennessee nut tree, steel components terra black	550.81.604
	From 550	Frame Bardolino oak, steel components silk white	550.81.405
		Frame Nebraska oak, steel components Orion grey	550.81.805
		Frame Tennessee nut tree, steel components terra black	550.81.605
2 cross-ways dividers	From 600	Frame Bardolino oak, steel components silk white	550.81.406
		Frame Nebraska oak, steel components Orion grey	550.81.806
		Frame Tennessee nut tree, steel components terra black	550.81.606

Packing: 1 piece

→ Crossways divider for narrow frame

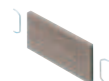

Width 88 mm

- > Version: For further subdivision of narrow frames
- > Material: Wood decor
- > Width: 88 mm
- > Height: 50 mm
- > Installation: With spring clip for inserting
- > Model: ZC7Q010SH

Finish	Cat. No.
Bardolino oak	550.81.458
Nebraska oak	550.81.858
Tennessee nut tree	550.81.658

Packing: 1 piece

Wide frame

For drawer sides with system height M and K
(height 50 mm)

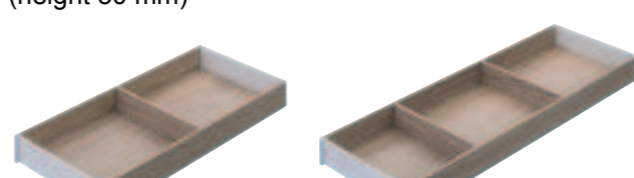

Nominal length 450–550 mm
(1 crossways divider)

Nominal length 600 mm
(2 crossways dividers)

- > Version: For inserting in drawers, with base
- > Material: Wood decor/steel
- > Width: 200 mm
- > Model: ZC7S450(500/550/600)RH2

	For nominal length mm	Finish	Cat. No.
1 cross-ways divider	From 450	Frame Bardolino oak, steel components silk white	550.81.414
		Frame Nebraska oak, steel components Orion grey	550.81.814
		Frame Tennessee nut tree, steel components terra black	550.81.614
	From 500	Frame Bardolino oak, steel components silk white	550.81.415
		Frame Nebraska oak, steel components Orion grey	550.81.815
		Frame Tennessee nut tree, steel components terra black	550.81.615
	From 550	Frame Bardolino oak, steel components silk white	550.81.416
		Frame Nebraska oak, steel components Orion grey	550.81.816
		Frame Tennessee nut tree, steel components terra black	550.81.616
2 cross-ways dividers	From 600	Frame Bardolino oak, steel components silk white	550.81.417
		Frame Nebraska oak, steel components Orion grey	550.81.817
		Frame Tennessee nut tree, steel components terra black	550.81.617

Packing: 1 piece

→ Crossways divider for wide frame



Width 188 mm

- > Version: For further subdivision of wide frames
- > Material: Wood decor
- > Width: 188 mm
- > Height: 50 mm
- > Installation: With spring clip for inserting
- > Model: ZC7Q020SH

Finish	Cat. No.
Bardolino oak	550.81.468
Nebraska oak	550.81.868
Tennessee nut tree	550.81.668

Packing: 1 piece

DGH-M 2017, HDE-en, 10/16; Dimensional data not binding. We reserve the right to alter specifications without notice.

Cross railing

For pots and pans, supplies and plastic containers

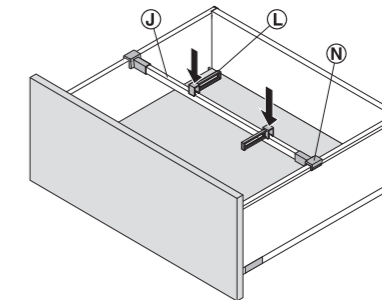

- Ⓝ Railing
- Ⓛ Lengthways divider
- Ⓝ Railing holder

→ Railing Ⓝ

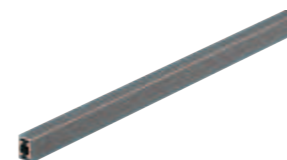

- > Material: Aluminium
- > For cabinet width: Max. 1,200 mm (16 mm side panel thickness)
- > Length: 1,080 mm
- > Installation: For cutting to size: Internal cabinet width – 90 mm, for plug fitting into front bracket (cross railing)
- > Model: ZR7.1080U

Model	Colour	Cat. No.
ZR7.1080U	Matt Orion grey	550.74.508
	Matt silk white	550.74.708
	Matt terra black	550.74.308
	Matt polar silver	550.74.908

Packing: 1 piece

Order reference

Please order railing holder Ⓝ separately.

→ Railing holder Ⓝ



- > Material: Plastic
- > Model: ZC7U10E0

Colour	Cat. No.
Matt Orion grey	550.74.580
Matt silk white	550.74.780
Matt terra black	550.74.380
Matt polar silver	550.74.980

Packing: 1 piece

Order reference

Please order 2 railing holders for each cross railing.

→ Lengthways divider Ⓛ



- > Material: Plastic
- > Length: 84 mm
- > Model: ZC7U10F0

Colour	Cat. No.
Matt Orion grey	550.74.585
Matt silk white	550.74.785
Matt terra black	550.74.385
Matt polar silver	550.74.985

Packing: 1 piece

Blum Legrabox drawer side runner system

► MB 9.72



9

Drawer and Pull Out for Door Front Fixing



9

Drawer and Pull Out