



The TGM-Compact  
The electric chain hoist is  
supplied with chain box,  
chain, and TGMCommander  
and it is ready for  
immediate installation.



#### Option: Remote control

**Remote control option:** Hoisting and lowering – wireless and independent of location with the radio-controlled Mini RC as part of our supplementary equipment. The receiver is simply plugged into the chain hoist in the place of the push button pendant.

## Electric chain hoists for 230V or 400 V

### TGM-ABUCompact for 230 V/50 Hz

Handy, immediately operational electric chain hoist with 230-V two-prong grounded plug, for **weights up to 200 kg**. The special advantages of the TGM-Compact: Due to the low dead weight and the possibility of connecting it via a normal 230-V outlet, this compact chain hoist can be utilized flexibly at workstations within enclosed halls. The speed can be **infinitely** adjusted via the TGMCommander (**up to 12 m per minute**).

Order No.	Load-carrying capacity kg	Chain strand No.	Infinitely adjustable travel m/min.	Hook travel m	FEM grading mm	Dead weight kg
TGMC100/03	100	1	0.7 – 12	3	1Am	10
TGMC100/06	100	1	0.7 – 12	6	1Am	11
TGMC100/10	100	1	0.7 – 12	10	1Am	12
TGMC100/20	100	1	0.7 – 12	20	1Am	14
TGMC200/03	200	2	0.3 – 6	3	1Am	12
TGMC200/06	200	2	0.3 – 6	6	1Am	13
TGMC200/10	200	2	0.3 – 6	10	1Am	15

The corresponding manual running gear THF3 can be found on page H 59.

### Electric TGM ABUCompact chain hoists for 400 V/50 Hz

Torwegge electric chain hoists are particularly impressive through their practical and user-friendly advantages: A particularly low overall height, standard creep hoist, and brake pads with extremely long service lives as well as an extensive range of supplementary equipment. And with load-carrying capacities up to 4.0 t.

#### Scope of supply

Electric chain hoist ready for connection, complete with chain and chain box. Folding and removable suspension bracket. Control via push button pendant with "emergency stop." Hook travel 3 m.

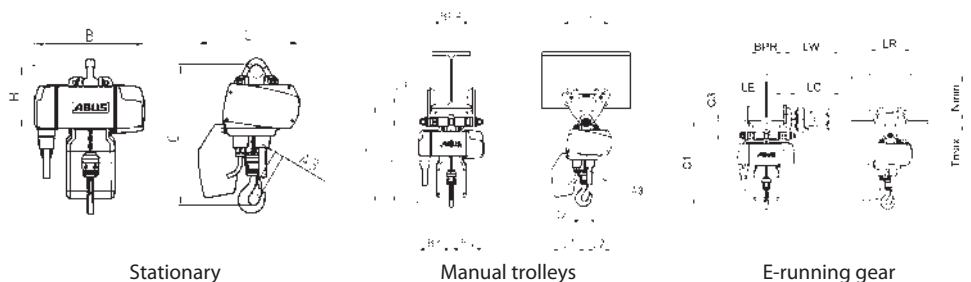

Stationary

Manual trolleys

E-running gear

Order No.	Load-carrying capacity kg	Chain strand No.	Main/ Creep hoist m/min.	FEM grading mm	Installation height			Dead weight kg
					C mm	C2 mm	C1 mm	
TGM2-125.8S	125	1	2/8	4m	344	357	–	22
TGM2-250.8S	250	1	2/8	2m	344	357	–	22
TGM2-500.4S	500	2	1/4	2m	425	394	–	25
TGM4-500.8S	500	1	2/8	2m	390	427	–	35
TGM4-1000.4S	1000	2	1/4	2m	470	527	–	38
TGM6-2000.4S	2000	2	1/4	2m	564	549	–	64
TGM6-2500.4S	2500	2	1/4	1Am	564	549	–	64
TGM8-3200.4S	3200	2	0,7/4	2m	674	816	–	101

\*) For running gear orders, we require details of the flange width BPR of the profile.  
Other designs are available on request.

- Load-carrying capacities 4000 kg
- Contactor control 48 V
- Electronic stroke limit switch
- Longer hook travel
- Radio-controlled Mini-RC
- Higher/lower hoisting speeds

## Manual trolleys THF for single-rail trolley tracks



- Low installation height.
- Sturdy design with roller bearings.
- Practically maintenance-free.
- Machined rollers.
- Can be used for all standardized beams.
- Climbing and fall protection.
- Easy to adjust.
- Color blue.

Order No.	Load-carrying capacity kg	Flange width from - to mm	Total length mm	Height mm	Wheel Ø mm	Wheel tread Ø mm	Weight kg
THF3/42-120	300	42 - 120	165	135	56	75	3.9
THF3/121-180	300	120 - 180	165	135	56	75	4.4
THF6/42-120	600	42 - 120	205	153	65	85	6.1
THF6/121-220	600	121 - 220	205	153	65	85	6.7
THF14/64-125	1400	64 - 125	250	193	80	100	11
THF14/126-200	1400	126 - 200	250	193	80	100	11.7
THF14/201-300	1400	201 - 300	250	193	80	100	12.6
THF22/82-150	2200	82 - 150	320	236	112	140	23.2
THF22/151-200	2200	151 - 200	320	236	112	140	23.9
THF22/201-300	2200	201 - 300	320	236	112	140	25.8
THF36/90-155	3600	90 - 155	320	253	112	140	29.7
THF36/156-200	3600	156 - 200	320	253	112	140	30.4
THF36/201-300	3600	201 - 300	320	253	112	140	32.2
THF50/100-195	5000	100 - 195	400	348	140	180	65.5
THF50/200-305	5000	200 - 305	400	348	140	180	70.5

Max. bend radius on request.

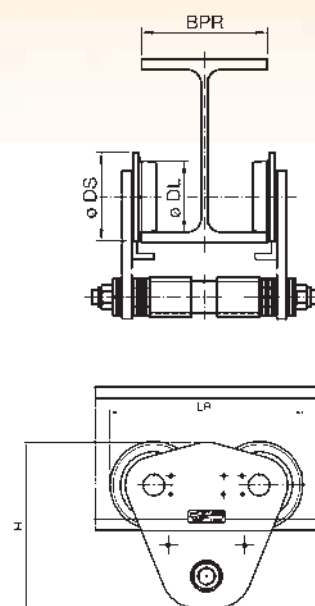

## TEF electric trolleys for single-rail trolley tracks



Robust construction fitted with roller bearings - practically maintenance-free - machined rollers - can be used for all standardized beams - climbing and fall protection - easy to adjust - electromechanical, durable disc brake

- Color blue.
- Operating voltage 400V/50Hz.
- Driving speed 5/20 m/min.
- Protection class IP 55.
- Duty cycle 40%.

Order No.	Load-carrying capacity kg	Flange width from - to mm	Total length mm	Height mm	Wheel Ø mm	Wheel tread Ø mm	Weight kg
TEF14/64-125	1400	64 - 125	265	193	80	100	37.1
TEF14/126-200	1400	126 - 200	265	193	80	100	37.8
TEF14/201-300	1400	201 - 300	265	193	80	100	27.1
TEF22/82-150	2200	82 - 150	335	236	112	140	49.4
TEF22/151-200	2200	151 - 200	335	236	112	140	38.6
TEF22/201-300	2200	201 - 300	335	236	112	140	40.5
TEF36/90-155	3600	90 - 155	335	253	112	140	43.9
TEF36/156-200	3600	156 - 200	335	253	112	140	44.2
TEF36/201-300	3600	201 - 300	335	253	112	140	46.5
TEF50/100-195	5000	100 - 195	403	348	140	180	87.9
TEF50/200-305	5000	200 - 305	403	348	140	180	92.9

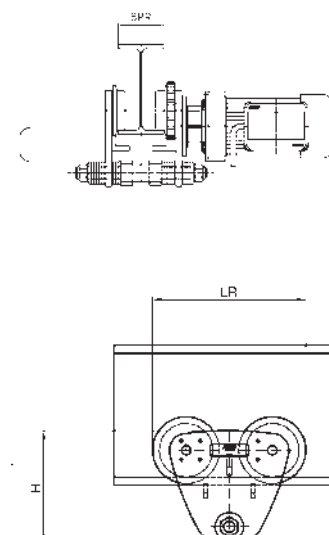



# TORWEGGE pulleys, gate and guide rollers

Page	Caster series	Load-carrying capacity
R 115	 <b>E, SEK, 055, FGF</b>	35 – 500 kg
R 116	 <b>F, 318, 308</b>	35 – 175 kg
R 117	 <b>50, HB, 595, CF</b>	35 – 750 kg
R 118	 <b>CF/300, CF/305, CF/320</b>	70 – 800 kg
R 119	 <b>CF/310, CF/315, CF/323</b>	70 – 800 kg
R 120	 <b>CF/310I, CF/315I, CF/230I</b>	75 – 625 kg

**Areas of application:**



Pulleys



Gate runner rollers



Guide rollers

**Pulleys**

**Series E**



Ident. No.	Order No.	mm	mm	mm	mm	mm	mm	kg
0015933	E040-1	040/032	12	15	16.5	6	8	35
0015934	E048-1	048/040	12	15	16.5	8	8	42
0015935	E050-1	050/040	10	11	25	15	4	30
0015936	E060-1	060/038	30	18	28	12	20	90
0015937	E065-1	065/057	12	15	16.5	8	8	50
0015938	E073-1	073/065	13	17	20	10	8	55
0015939	E076-1	076/066	15	17	20	11	11	75
0015940	E080-1	080/062	22	25	30	12	12	140
0015941	E090-1	090/070	18	21	21	10	10	130
0015942	E100-1	100/084	12	17	30	10	3.5	85
0015943	E100-2	100/074	25	28	38	15	18	160
0015944	E100-3	100/068	42	27	50	20	28	270
0015946	E120-1	120/088	27	33	40	15	18	300
0015947	E126-1	126/102	34	42	70	30	14	500
0015948	E150-1	150/110	33	42	46	20	25	410



► Made of polyamide 6 with **plain bearing** and semicircular groove

**Pulleys**

**Series SEK**



Ident. No.	Order No.	mm	mm	mm	mm	mm	mm	kg
0023791	SEK/040	040/030	13	7	-	8	5	50
0023792	SEK/050	050/038	13	9	-	10	4	50
0023794	SEK/065-2	065/055	12	8	-	10	8	137
0023795	SEK/078-1	078/056	15	5	32	10	8	138
0023796	SEK/078-2	078/066	19	10	43	15	12	245
0023798	SEK/080-2	080/050	21	10	-	15	8	125
0023799	SEK/098	098/080	20	20	-	10	6	150



► Made of polyamide 6 with **ball bearing** and semicircular groove

**Pulleys**

**Series 055**



Ident. No.	Order No.	mm	mm	mm	mm	mm	mm	kg
0010006	055/030	030/024	10	12	-	7.1	6	65
0010007	055/040	040/033	11	12	-	8.1	7	85
0010008	055/050	050/043	11	12	-	8.1	7	85
0010009	055/060	058/044	13	20	-	10.5	6	100
0010010	055/080	078/060	14	20	-	12.5	6	200
0027459	055/100	098/080	17	22	-	12.5	8	220
0027460	055/120	117/099	17	22	-	12.5	8	240



► Made of steel with **ball bearing** and semicircular groove

**Pulleys**

**Series FGF**



Ident. No.	Order No.	mm	mm	mm	mm	mm	mm	kg
0016518	FGF030	030/022	10	11	10	4,1	6	15
0016519	FGF040	040/032	12	13	10	5,1	6	18
0016520	FGF050	050/042	12	13	12	5,1	6	22
0016521	FGF060	060/050	12	13	19	5,1	8	22
0016522	FGF070	070/058	13	15	18	5,1	8	22
0016523	FGF080	080/068	16	17	18	5,1	8	22
0016524	FGF100	100/078	24	27	21	10,1	16	110
0016525	FGF120	120/098	27	31	34	10,1	16	140



► Made of special gray cast iron, with **plain bearing** and semicircular groove



- Made of polyamide 6 with **plain bearing** and angular groove

### Door rollers with angular grooves

### Series F

Ident. No.	Order No.	mm	mm	mm	mm	mm	mm	kg
0016339	F045-1	045/028	29	29	8	24/20	8.5	45
0016340	F050-1	050/034	16	16	12	14/10	8	35
0016341	F060-1/KS30x19.5	060/040	22	22	Kulasitz-30x19.5	12/10	10	40
0016342	F100-1	100/080	24	25	16	16/12	10	100
0016345	F122-1	122/092	30	35	16	16/15	15	120



- Made of special gray cast iron with **roller cage bearing**, axle and angular groove

### Door rollers with angular grooves

### Series 318

Ident. No.	Order No.	mm	mm	mm	mm	mm	kg
0011929	318/060S	060/048	28	36	M14 x 76	13/15	100
0011928	318/060	060/048	16	22	M10 x 50	06/08	30
0011932	318/075	075/059	19	28	M10 x 54	09/11	35
0011933	318/090	090/074	20	32	M10 x 61	09/11	50
0011934	318/105	105/087	22	34	M12 x 67	11/13	75
0011935	318/120	120/102	22	39	M12 x 73	11/13	100
0011936	318/140	140/120	27	47	M14 x 83	14/17	135
0011937	318/160	160/140	26	47	M14 x 83	14/17	175



- Door rollers made of special gray cast iron
- Bracket made of galvanized steel

### Door rollers with angular grooves

### Series 308

Ident. No.	Order No.	mm	mm	Bracket length	Bracket holes	Bracket width	Bracket thickness	kg
0011883	308/060S	60	13/15	450	10.5	70	10	100
0011882	308/060	60	06/08	265	6.1	25	5	30
0011884	308/075	75	09/11	315	8.5	30	6.5	35
0011885	308/090	90	09/11	400	10.5	40	6.5	50
0011886	308/105	105	11/13	465	10.5	40	8	75
0011887	308/120	120	11/13	535	10.5	45	8	100
0011888	308/140	140	14/17	600	10.5	45	10	130
0011889	308/160	160	14/17	615	10.5	55	10	175





**Pulleys**

**Series 50**



Ident. No.	Order No.	mm	mm	mm	mm	mm	mm	kg
0012649	50/075	075/057	19	28	M10 x 54	10	9	35
0012650	50/090	090/072	20	32	M10 x 61	10	9	30
0012651	50/105	105/085	21.5	34	M12 x 67	12	10	75
0012652	50/120	120/100	21.5	39	M12 x 75	12	10	100
0012653	50/140	140/118	26	45	M14 x 83	14	11	135
0012654	50/160	160/138	26	45	M14 x 83	14	11	175
0012655	50/200	200/178	26.5	49	M16 x 93	16	11	250

**Pulleys Series 50:**

- ▶ Made of special gray cast iron with roller cage bearing, axle, and semicircular groove

**Sectional gate rollers**

**Series HB**



Ident. No.	Order No.	Bearing type	mm	mm	kg	mm
0028710	HB/46/127/K	Ball bearing	46	13	60	11 x 127
0028711	HB/46/111/K	Ball bearing	46	13	60	11.95 x 109
0028712	HB/46/125/G	Plain bearing	46	13	60	11.95 x 125
0027665	PO/46/13/1K	Ball bearing	46	13	60	-

**Sectional gate rollers Series HB:**

- ▶ Polyamide running surface
- ▶ Steel axles

**Guide rollers for sliding gates**

**Series 594/595**



Ident. No.	Order No.	mm	mm	mm	mm	mm	kg
0013469	595/048	48	65	35	30	M16	200
0013468	594/048	48	81	52	40	M20	125
0013470	595/100	100	90	50	40	M24	750

**Guide rollers for sliding gates – Series 594/595**

- ▶ Wheels in series 594 made of polyamide with plain bearings
- ▶ Wheels in series 595 made of steel with ball bearings

**Guide rollers for sliding gates**

**Series CF/231 – CF/243**



Ident. No.	Order No.	mm	mm	mm	mm	mm	kg
0026854	CF/231/52	52	88,5	47	-	M16	125
0026855	CF/243/25	25	72	30	-	M12	70
0026856	CF/243/30	30	75,5	30	-	M14	75
0026857	CF/243/40	40	75,5	30	-	M14	80

**Guide rollers for sliding gates – Series CF/231 – CF/243**

- ▶ Wheels in series CF/231 made of polyamide with plain bearings and spherical treads
- ▶ Wheels in series CF/243 made of polyamide with plain bearings and cylindrical treads



With angular groove

### Caster series CF/300:

- ▶ Made of steel **with 1 ball bearing** and angular groove, galvanized
- ▶ With axle for driven sliding gates

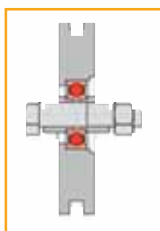

### Caster series CF/305:

- ▶ Made of steel **with 2 ball bearings** and angular groove, galvanized
- ▶ With axle for driven sliding gates

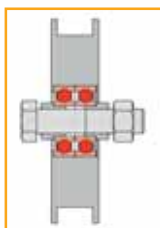

### Caster series CF/320:

- ▶ Made of steel **with 1 ball bearing** and angular groove, galvanized
- ▶ With axle for driven sliding gates

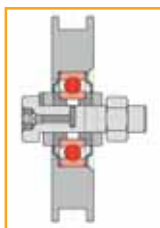

### Rollers for electrically driven sliding gates

### Series CF/300

Ident. No.	Order No.	mm	mm	mm	mm	mm	mm	kg
0026858	CF/300/50	050/042	12	17	M8 x 30	6	4	70
0026859	CF/300/60	060/046	16.5	24	M10 x 45	8	7	100
0026860	CF/300/80	078/062	20	34	M14 x 70	8	8	200
0026861	CF/300/100	098/082	21	34	M14 x 70	8	8	220
0026862	CF/300/140	137/117	25	44	M16 x 70	16	10	270
0026863	CF/300/160	157/137	25	44	M16 x 70	16	10	290
0026864	CF/300/200	197/177	25	44	M16 x 70	16	10	330

### Rollers for electrically driven sliding gates

### Series CF/305

Ident. No.	Order No.	mm	mm	mm	mm	mm	mm	kg
0026886	CF/305/100	098/078	28	34	M14 x 70	16	10	400
0026866	CF/305/120	117/097	28	34	M14 x 70	21	10	420
0026867	CF/305/160	157/137	33	44	M16 x 70	21	10	560
0026868	CF/305/200	197/177	33	44	M16 x 70	21	10	600

### Rollers for electrically driven sliding gates

### Series CF/320







Ident. No.	Order No.	mm	mm	mm	mm	mm	mm	kg
0026869	CF/320/160	157/137	31	44	M20 x 80	21	10	710
0026870	CF/320/200	197/177	31	44	M20 x 80	21	10	750
0026871	CF/320/250	247/255	34	54	M24 x 100	22	11	800



With semicircular groove

**Rollers for electrically driven sliding gates**

**Series CF/310**

Ident. No.	Order No.	 mm	 mm	 mm	 mm	 mm	 mm	 kg
0026872	CF/310/50	050/042	12	16	M8 x 30	9	4	70
0026873	CF/310/60	060/052	16.5	24	M10 x 45	9	4	100
0026874	CF/310/80	078/063	20	34	M14 x 70	10	7.5	200
0026875	CF/310/100	98/083	21	34	M14 x 70	10	7.5	220
0026876	CF/310/140	137/118	25	44	M16 x 70	21	9.5	270
0026877	CF/310/160	157/138	25	44	M16 x 70	21	9.5	290
0026878	CF/310/200	197/178	25	44	M16 x 70	21	9.5	330





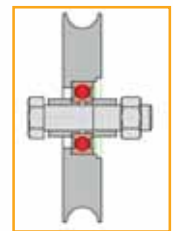

**Caster series CF/310:**

- ▶ Made of steel **with 1 ball bearing** and semicircular groove, galvanized
- ▶ With axle for driven sliding gates



**Rollers for electrically driven sliding gates**

**Series CF/315**

Ident. No.	Order No.	 mm	 mm	 mm	 mm	 mm	 mm	 kg
0026879	CF/315/100	098/079	28	34	M14 x 70	21	9.5	400
0026880	CF/315/120	117/098	28	34	M14 x 70	21	9.5	420
0026881	CF/315/160	157/138	33	44	M16 x 70	23	9.5	560
0026882	CF/315/200	197/178	33	44	M16 x 70	23	9.5	600





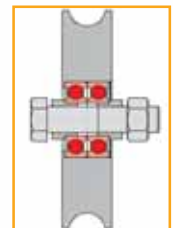

**Caster series CF/315:**

- ▶ Made of steel **with 2 ball bearings** and semicircular groove, galvanized
- ▶ With axle for driven sliding gates



**Rollers for electrically driven sliding gates**

**Series CF/323**

Ident. No.	Order No.	 mm	 mm	 mm	 mm	 mm	 mm	 kg
0026883	CF/323/160	157/138	31	44	M20 x 80	23	9.5	710
0026884	CF/323/200	197/178	31	44	M20 x 80	23	9.5	750
0026885	CF/323/250	247/228	34	54	M24 x 100	23	9.5	800

**Caster series CF/323:**

- ▶ Made of steel **with 1 ball bearing**, semicircular groove, and lubrication nipple, galvanized
- ▶ With axle for driven sliding gates

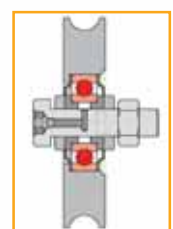





### Stainless steel pulleys series CF/310I:

- Made of stainless steel with 1 ball bearing

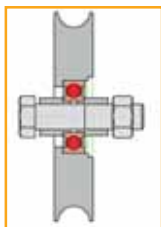

### Stainless steel pulleys series CF/315I:

- Made of stainless steel with 2 ball bearings

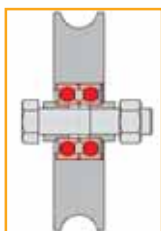

### Stainless steel guide rollers Series 230I:

- Made of polyamide with plain bearings
- Spherical running surface

### Stainless steel pulleys

### Series CF/310I



Ident. No.	Order No.	mm	mm	mm	mm	mm	mm	kg
0026892	CF/310I/60	060/051	16.5	24	M10 x 45	14	4.5	150
0026893	CF/310I/80S	078/057	24	34	M14 x 70	18	10.3	225
0026894	CF/310I/100S	098/77	24	34	M14 x 70	18	10.3	275
0026895	CF/310I/120	117/096	25	34	M16 x 70	18	10.3	300
0026896	CF/310I/160	157/136	25	44	M16 x 70	18	10.3	350
0026897	CF/310I/200	197/176	25	44	M16 x 70	18	10.3	400



### Stainless steel pulleys

### Series CF/315I



Ident. No.	Order No.	mm	mm	mm	mm	mm	mm	kg
0026898	CF/315I/100	098/079	28	34	M14 x 70	21	9.5	425
0026899	CF/315I/120	117/098	28	34	M14 x 70	21	9.5	450
0026900	CF/315I/140	137/118	31	44	M16 x 70	23	9.5	550
0026901	CF/315I/160	157/138	33	44	M16 x 70	23	9.5	575
0026902	CF/315I/200	197/178	33	44	M16 x 70	23	9.5	625



### Stainless steel guide rollers

### Series 230I



Ident. No.	Order No.	mm	mm	mm	mm	kg
0026903	CF/230I/30	30	74	40	M16	75
0026904	CF/230I/40	39	98	58	M16	80

