

500 mm

4 side metal drawer



COLOURS



Aluminium



Black

TECHNICAL DETAILS

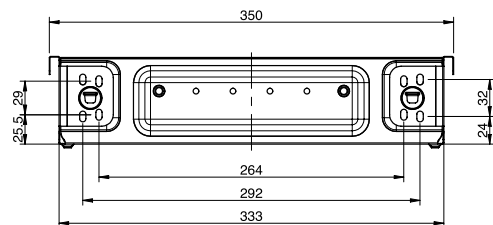
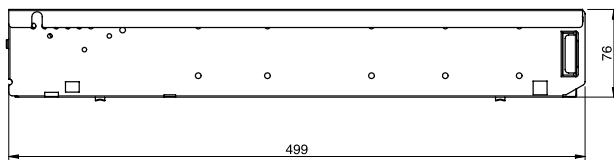

APPLIABLE SLIDES

Single extension roller slide  
500 mm  
aluminium colour



Single extension roller slide  
500 mm  
black colour



Full extension ball bearing slide  
500 mm  
zinc-plated



Full extension ball bearing slide  
500 mm  
black colour



700 mm

4 side metal drawer



COLOURS



Aluminium



Black

TECHNICAL DETAILS

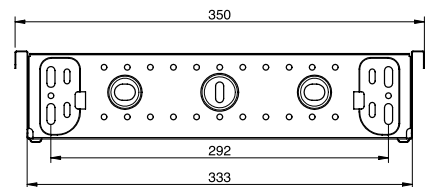
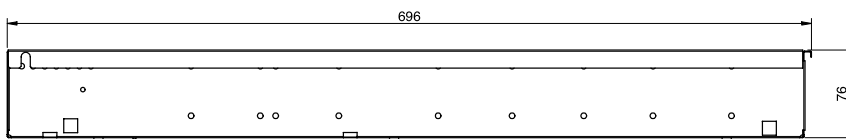

APPLIABLE SLIDES

Single extension roller slide  
700 mm  
aluminium colour



Single extension roller slide  
700 mm  
black colour



Full extension ball bearing slide  
720 mm  
black colour



500 mm

Filing frame

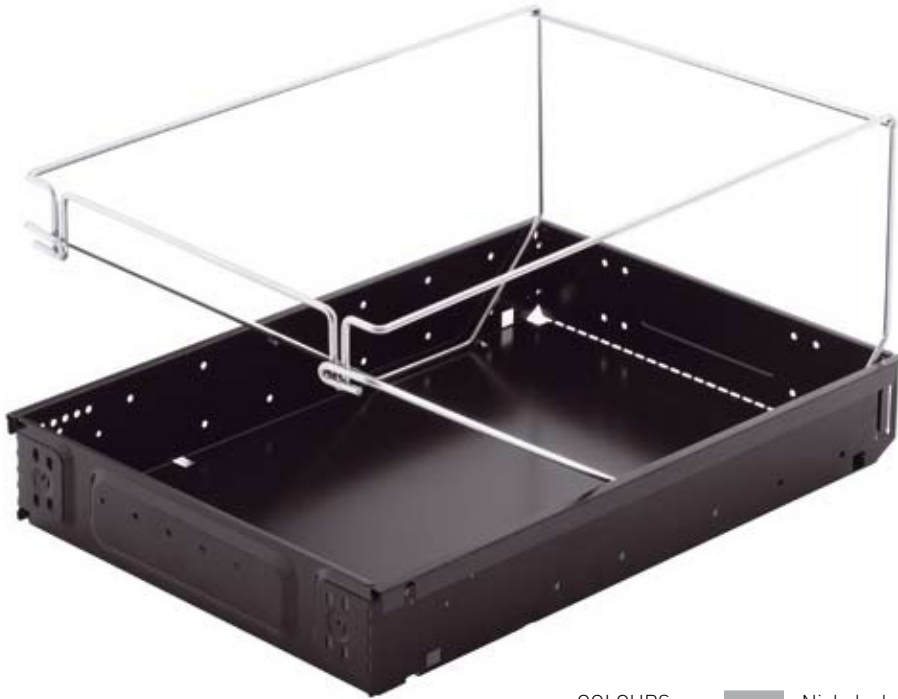

COLOURS  Nickel-plated

**PCF5C001**

TECHNICAL DETAILS

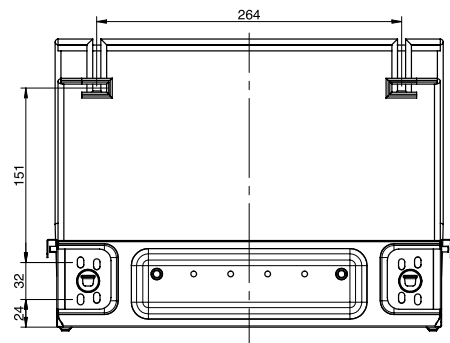
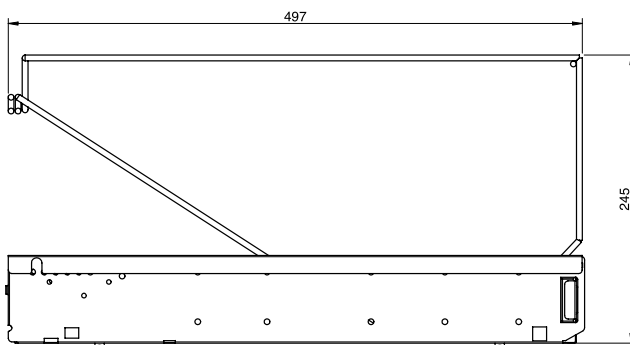

ACCESSORIES

Nickel-plated file drawer reductor 330 mm



500 mm

Filing frame



COLOURS  Black

#### TECHNICAL DETAILS

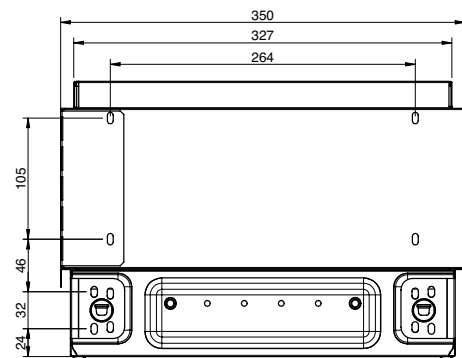
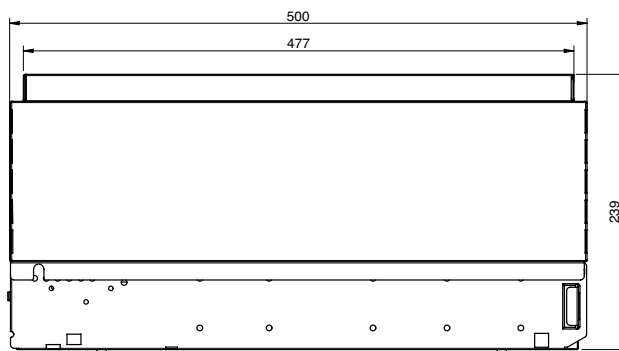

#### ACCESSORIES

Black metal file drawer reductor 330 mm



700 mm

Filing frame

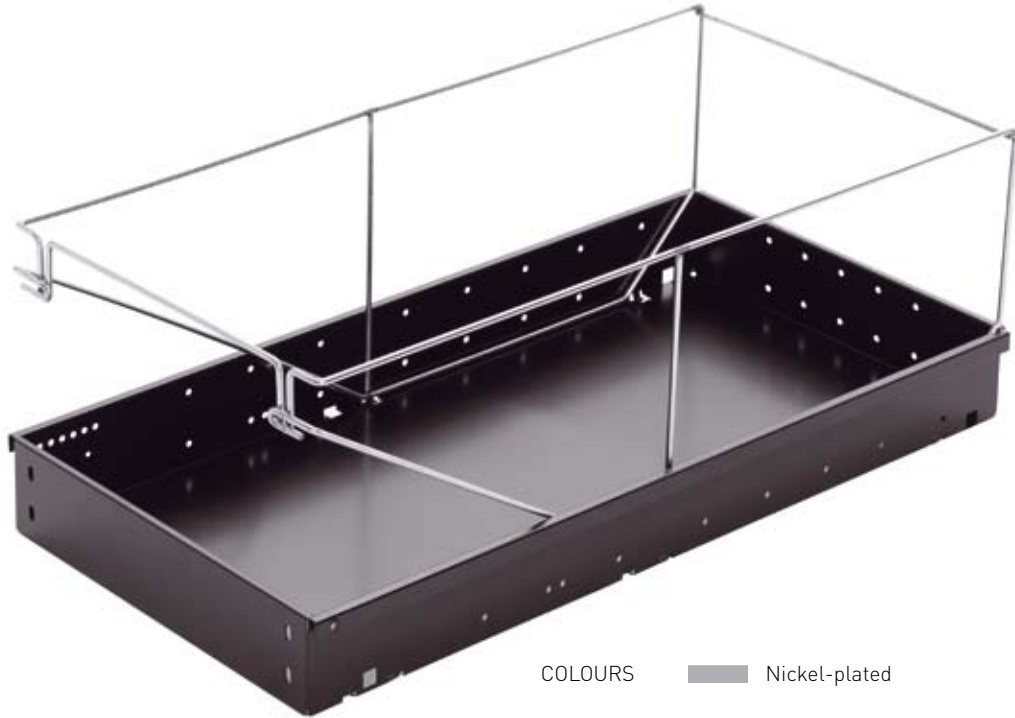

TECHNICAL DETAILS

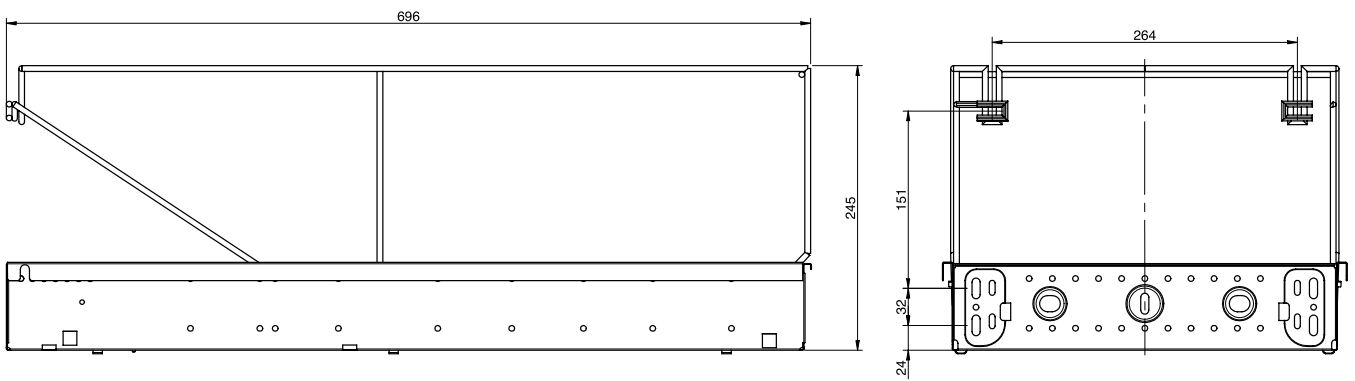

ACCESSORIES

Nickel-plated file drawer reductor 330 mm



Metal stationery drawer



COLOURS  Aluminium  Black

TECHNICAL DETAILS

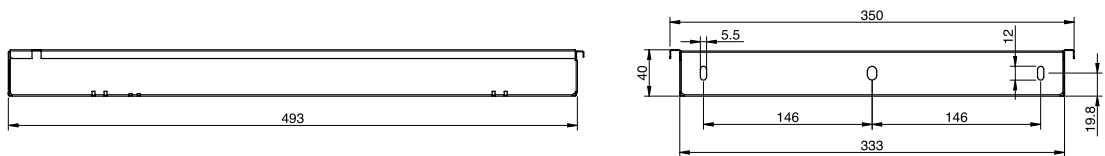

APPLIABLE SLIDES

Single extension roller slide  
 500 mm  
 aluminium colour



Single extension roller slide  
 500 mm  
 black colour



Plastic stationery drawers completed with zinc-plated ball bearing slides

TECHNICAL DETAILS



COLOURS  Black

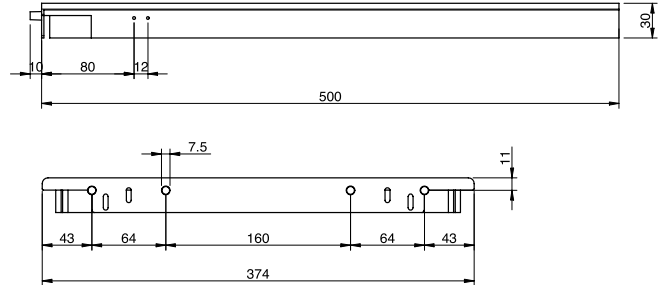

COLOURS  Black

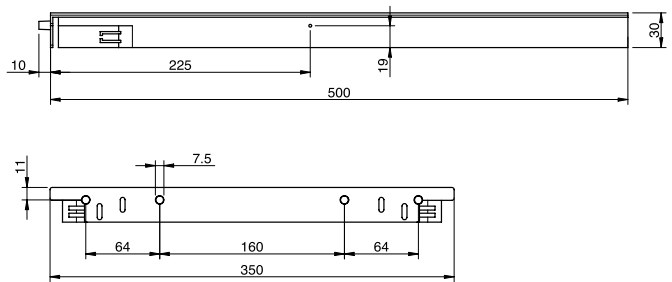

COLOURS  Black

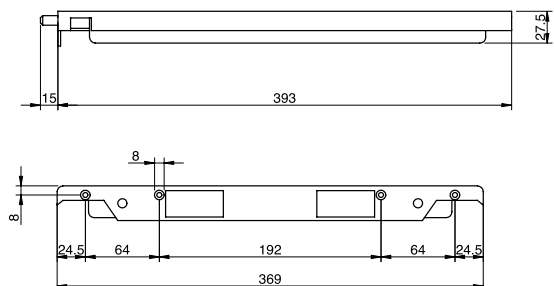

400 mm

Locking bar



1. Locking bar H 400 mm for 3 metal box dr. pedestals inner size 380 mm + antitilt device
2. Locking bar H 400 mm for 3 metal box dr. pedestals inner size 358 mm + antitilt device
3. Locking bar H 400 mm for 1 metal box dr. + 1 metal file dr. pedestals inner size 380 mm + antitilt device
4. Locking bar H 400 mm for 1 metal box dr. + 1 metal file dr. pedestals inner size 358 mm + antitilt device
5. Locking bar H 400 mm for 1 stat.dr. + 3 metal box dr. pedestals inner size 380 mm + antitilt device
6. Locking bar H 400 mm for 1 stat.dr. + 3 metal box dr. pedestals inner size 358 mm + antitilt device
7. Locking bar H 400 mm for 1 stat.dr. + 1 metal box dr. + 1 metal file dr. pedestals inner size 380 mm + antitilt device
8. Locking bar H 400 mm for 1 stat.dr. + 1 metal box dr. + 1 metal file dr. pedestals inner size 358 mm + antitilt device

box dr. = box drawer

file dr. = file drawer

stat. dr. = stationery drawer

#### LOCK ACTIVATORS

Lock bar slide screw on assembly

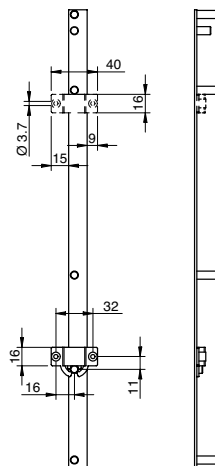

Lock bar slide screw on assembly with clip





Antitilt device for metal drawer



TECHNICAL DETAILS

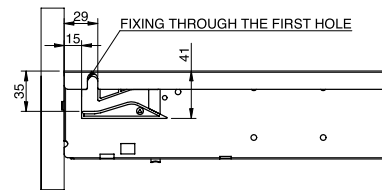

Antitilt device for pvc drawer



TECHNICAL DETAILS

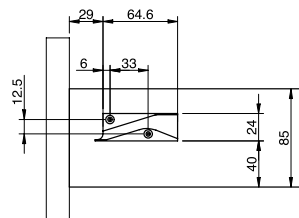

Keylock with Ø18 mm extractable barrel



Keylock with extractable barrel Ø18 mm,  
 1 flap, 1 bending key, 1 metal key,  
 200 combinations

TECHNICAL DETAILS

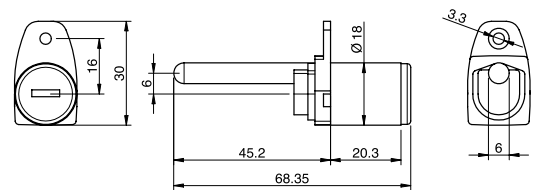

Master key



Key to extract barrel







INNER SIZE 380 MM

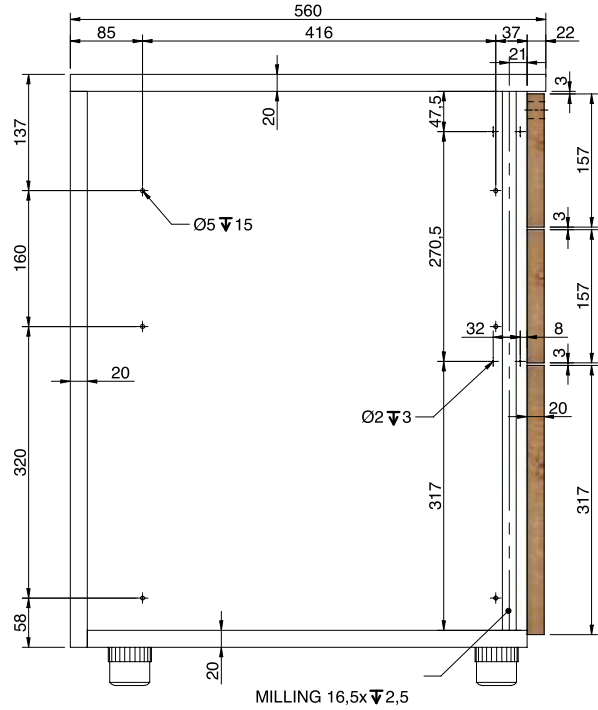
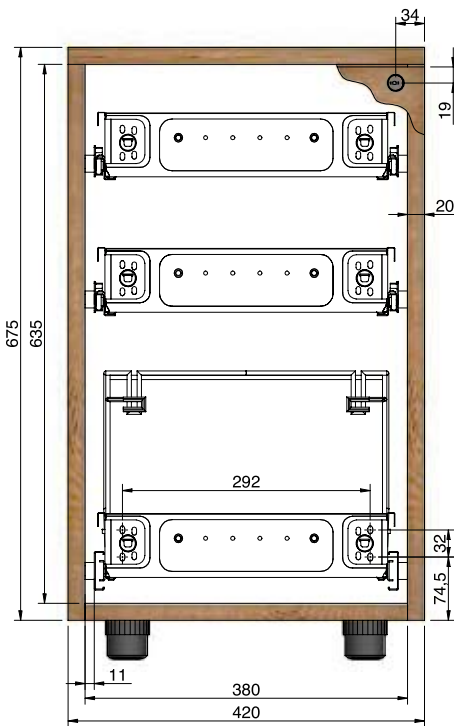

INNER SIZE 358 MM

