

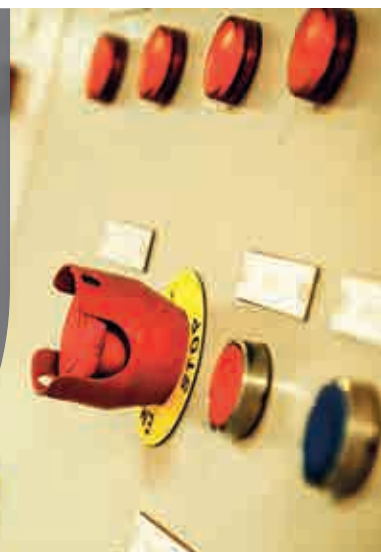



















METALIKA

KOMPONENTE ZA INDUSTRIJO **KACIN**

AUTOMATION AND CONTROL SOLUTIONS

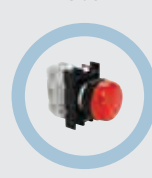
- Over 200 cost-effective parts, irrelevant of project size or quantity
- IP50 and IP65 control units suitable for both indoor and outdoor assemblies
- Safety regulation compliant



 362	 362	 363	 363	 364	 364	 364
 365	 365	 366	 367	 367	 368	 368
 369	 369	 370	 371	 372	<p>MORE THAN 200 AUTOMATION AND CONTROL PRODUCTS AVAILABLE</p>	

AUTOMATION AND CONTROL



CONTROL UNITS

362



PILOT LIGHTS

369



CAM SWITCHES

371



THERMOSTATS

373

IP50 Plastic Body Push Button

SR 3000
Polyamide



- To fit Ø22 mm cut out with flush finish with spring return
- Temperature from -15°C to 70°C
- Range of colours to meet various needs
- Operating current: 4A
- Operating voltage: 250V AC

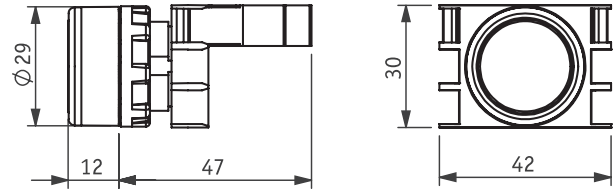

Assembly Dimension Ø22.4 ±0.2 mm

Part Number	Contact Type	Colour	Standard Pack Quantity
1339782	1NO	Green	10
1339783	1NO	White	10
1339784	1NO	Blue	10
1339785	1NO	Yellow	10
1339786	1NO	Black	10
1339787	1NC	Red	10

IP50 Plastic Body Double Headed Push Button

SR 3001
Polyamide



Flush button version



Extended button version

- To fit Ø22 mm cut out with flush finish with spring return
- Temperature from -15°C to 70°C
- Range of colours to meet various needs
- Operating current: 4A
- Operating voltage: 250V AC

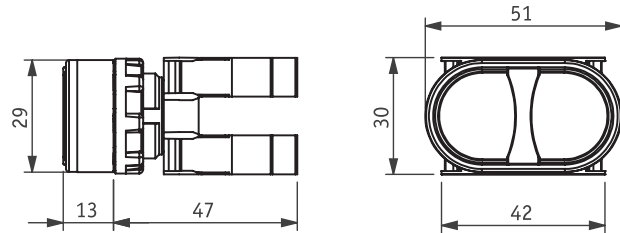

Assembly Dimension Ø22.4 ±0.2 mm

Part Number	Contact Type	Button Type	Colour	Standard Pack Quantity
1339788	1NO + 1NC	Flush	Red - Green	8
1339789	1NO + 1NC	Flush	Black - White	8
1339790	1NO + 1NC	Extended	Red - Green	8
1339791	1NO + 1NC	Extended	Black - White	8

IP50 Plastic Body Selector

SR 3002

Polyamide

- To fit Ø22 mm cut out
- Temperature from -15°C to 70°C
- Operating current: 4A
- Operating voltage: 250V AC



Part Number	Contact Type	Type	Position	Standard Pack Quantity
1339792	1NO	-	0-1	10
1339793	1NO	Spring return	0-1	10
1339794	2NO	-	2-0-1	10
1339795	2NO	Single spring return	2-0-1	10
1339796	2NO	Double spring return	2-0-1	10

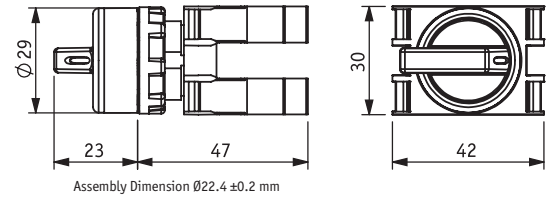

IP50 Plastic Emergency Button

SR 3003

Polyamide

- To fit Ø22 mm cut out
- Temperature from -15°C to 70°C
- Operating current: 4A
- Operating voltage: 250V AC



Label version

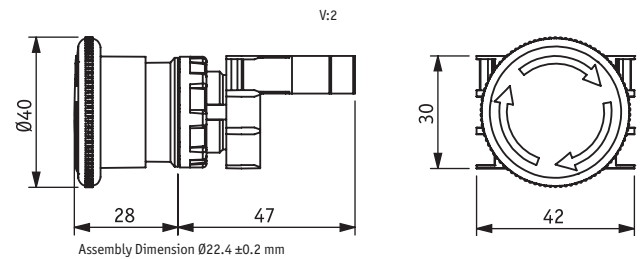
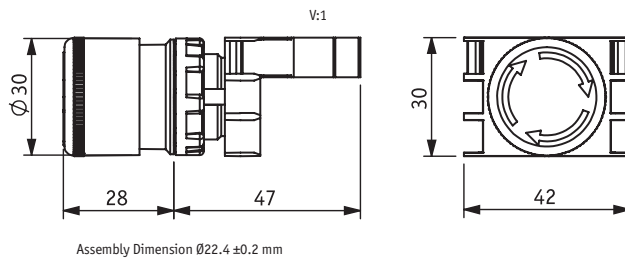

Part Number	Contact Type	Version	Standard Pack Quantity
1339797	1NC	1 (No Label)	10
1339798	1NC	1 (Label version)	10
1339799	1NC	2	10

IP50 Plastic Body Key Operated Push Button

SR 3004

Polyamide



- To fit Ø22 mm cut out
- Temperature from -15°C to 70°C
- Operating current: 4A
- Operating voltage: 250V AC

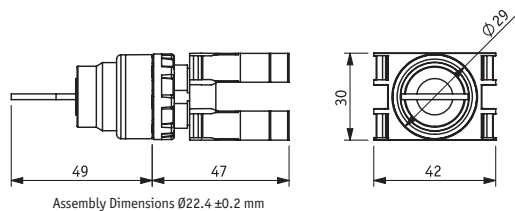

Part Number	Contact Type	Type	Position	Standard Pack Quantity
1339801	1NO	Stay put	0-1	10
1339802	1NO + 1NC	Spring releasable	0-1	10
1339803	1NO	Single spring releasable	2-0-1	10
1339804	2NO	Double spring releasable	2-0-1	10
1339805	1NO	Key removal	0-1	10
1339806	1NO + 1NC	Key removal	2-0-1	10

IP50 Control Unit Accessories

SR 3005

Polyamide

- To be used with Essentra IP50 Control Units
- Temperature from -15°C to 70°C
- Range of colours to meet various needs
- Operating current: 4A
- Operating voltage: 250V AC

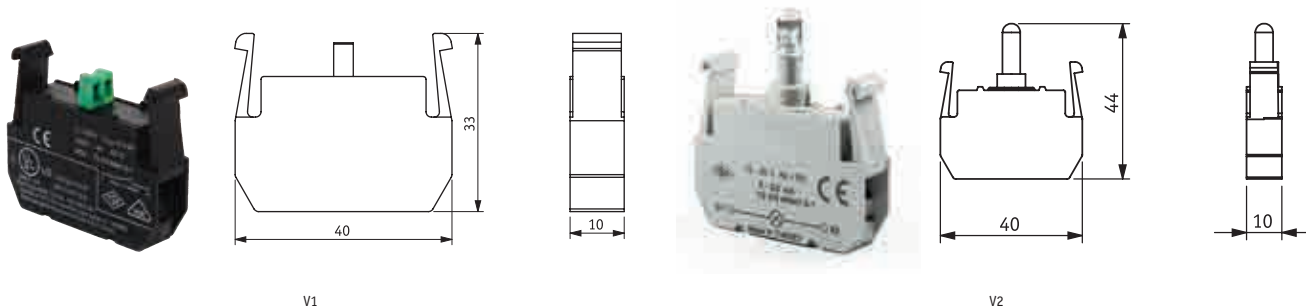

Part Number	Version	Type	Contact Type	LED Colour	Standard Pack Quantity
1339807	1	Contact block	1 NO	-	20
1339808	1	Contact block	1 NC	-	20
1339809	1	Contact block	Light contact block	-	20
1339810	2	Illumination block with LED	12 - 30 V AC / DC	White	20
1339811	2	Illumination block with LED	12 - 30 V AC / DC	Red	20
1339812	2	Illumination block with LED	12 - 30 V AC / DC	Blue	20
1339813	2	Illumination block with LED	12 - 30 V AC / DC	Yellow	20
1339814	2	Illumination block with LED	12 - 30 V AC / DC	Green	20
1339815	2	Illumination block with LED	100 - 230 V AC	White	20
1339816	2	Illumination block with LED	100 - 230 V AC	Red	20
1339817	2	Illumination block with LED	100 - 230 V AC	Blue	20
1339818	2	Illumination block with LED	100 - 230 V AC	Yellow	20
1339819	2	Illumination block with LED	100 - 230 V AC	Green	20

IP65 Plastic Body Push Button

SR 3006

Polyamide

- To fit $\varnothing 22$ mm cut out with flush finish with spring return
- Temperature from -15°C to 70°C
- Range of colours to meet various needs
- Operating current: 4A
- Operating voltage: 230V AC

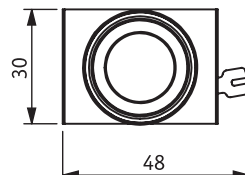
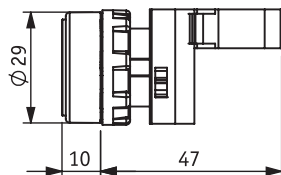

Assembly Dimension $\varnothing 22.4 \pm 0.2$ mm



Part Number	Contact Type	Colour	Standard Pack Quantity
1339713	1NO	Green	10
1339714	1NO	White	10
1339715	1NO	Blue	10
1339716	1NO	Yellow	10
1339717	1NO	Black	10
1339718	1NC	Red	10

IP65 Plastic Body Double Headed Push Button

SR 3007

Polyamide

- To fit $\varnothing 22$ mm cut out with flush finish with spring return
- Temperature from -15°C to 70°C
- Range of colours to meet various needs
- Operating current: 4A
- Operating voltage: 230V AC

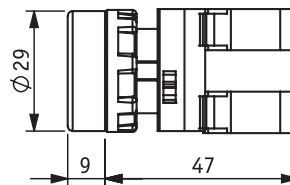
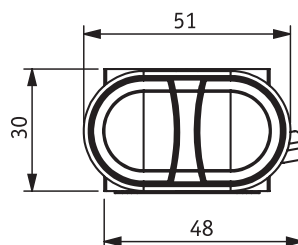

Assembly Dimension $\varnothing 22.4 \pm 0.2$ mm



Flush button version



Extended button version

Part Number	Contact Type	Button Type	Colour	Standard Pack Quantity
1339725	1NO + 1NC	Flush	Red - Green	8
1339726	1NO + 1NC	Flush	Black - White	8
1339727	1NO + 1NC	Extended	Red - Green	8
1339728	1NO + 1NC	Extended	Black - White	8

IP65 Metal Head Push Button

SR 3008

Polyamide

- To fit Ø22 mm cut out with flush finish with spring return
- Temperature from -15°C to 70°C
- Range of colours to meet various needs
- Operating current: 4A
- Operating voltage: 230V AC

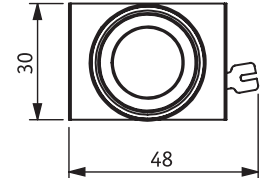
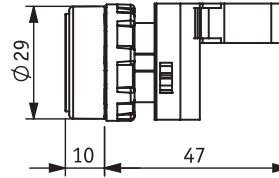

Assembly Dimensions Ø22.4 ±0.2 mm

Part Number	Contact Type	Colour	Standard Pack Quantity
1339719	1NO	White	10
1339720	1NO	Blue	10
1339721	1NO	Yellow	10
1339722	1NO	Green	10
1339723	1NO	Black	10
1339724	1NC	Red	10

IP65 Metal Double Headed Push Button

SR 3009

Polyamide

- To fit Ø22 mm cut out with flush finish with spring return
- Temperature from -15°C to 70°C
- Range of colours to meet various needs
- Operating current: 4A
- Operating voltage: 230V AC

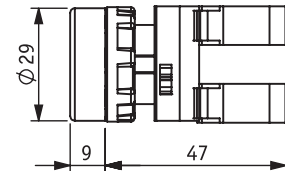
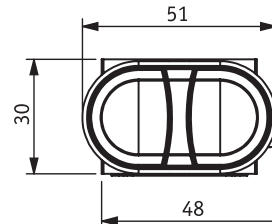

Assembly Dimensions Ø22.4 ±0.2 mm



Flush button version



Extended button version

Part Number	Contact Type	Button Type	Colour	Standard Pack Quantity
1339729	1NO + 1NC	Flush	Red - Green	8
1339730	1NO + 1NC	Flush	Black - White	8
1339731	1NO + 1NC	Extended	Red - Green	8
1339732	1NO + 1NC	Extended	Black - White	8

IP65 Body Selector

SR 3010
Polyamide



- To fit Ø22 mm cut out with flush finish
- Temperature from -15°C to 70°C
- Operating current: 4A
- Operating voltage: 230V AC

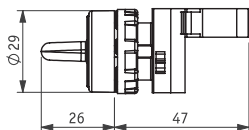

Assembly Dimension Ø22.4 ±0.2 mm

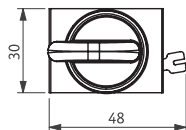

Plastic version



Metal version

Part Number	Material	Contact Type	Type	Position	Standard Pack Quantity
1339733	Plastic	1NO	Stay put	0-1	10
1339734	Plastic	1NO	Spring return	0-1	10
1339735	Metal	1NO	Stay put	0-1	10
1339736	Metal	1NO	Spring return	0-1	10
1339737	Metal	2NO	Stay put	2-0-1	10
1339738	Metal	2NO	Single spring return	2-0-1	10
1339739	Metal	2NO	Double spring return	2-0-1	10

IP65 Emergency Button

SR 3011
Polyamide



- To fit Ø22 mm cut out
- Temperature from -15°C to 70°C
- Operating current: 4A
- Operating voltage: 230V AC



V:3



V:4



V:1



V:2



V:5



V:6



V:7



V:8

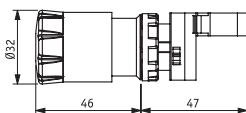

Assembly Dimension Ø22.4 ±0.2 mm

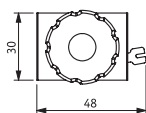

V: 3, 4, 5 & 6

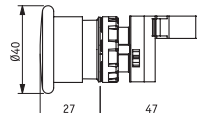

Assembly Dimension Ø22.4 ±0.2 mm

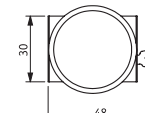

V: 1, 2, 7 & 8

Part Number	Version	Material	Contact Type	Version	Diameter (mm)	Standard Pack Quantity
1339740	1	Plastic	1NC	Turn to release	40	10
1339741	2	Plastic	1NC	With label	40	10
1339742	3	Plastic	1NC	Turn to release	30	10
1339743	4	Plastic	1NC	Turn to release	30	10
1339744	5	Plastic	1NC	Pull to release	30	10
1339745	6	Plastic	1NC	Pull to release	30	10
1339746	7	Plastic	1NC	With window pull	40	10
1339748	8	Metal	1NC	Spring return	40	10

IP65 Key Operated Push Button

SR 3012

Polyamide



- To fit Ø22 mm cut out with flush finish
- Temperature from -15°C to 70°C
- Operating current: 4A
- Operating voltage: 230V AC



Plastic Version



Metal Version

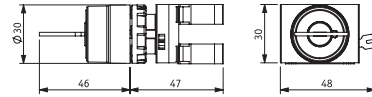

Assembly Dimension Ø22.4 ±0.2 mm

Part Number	Material	Contact Type	Type	Position	Standard Pack Quantity
1339751	Plastic	1NO	Stay put	0-1	10
1339752	Plastic	2NO	Single spring releasable	2-0-1	10
1339753	Plastic	2NO	Double spring releasable	2-0-1	10
1339754	Plastic	1NO	Stay put	0-1	10
1339755	Plastic	1NO	Stay put	2-0-1	10
1339756	Metal	1NO	Stay put	0-1	10
1339757	Metal	1NO	Spring return	0-1	10
1339758	Metal	2NO	Single spring releasable	2-0-1	10
1339759	Metal	2NO	Double spring releasable	2-0-1	10
1339760	Metal	1NO	Stay put	0-1	10
1339761	Metal	1NO	Stay put	2-0-1	10

IP65 Control Unit Accessories

SR 3013

Polyamide



- To be used with Essentra IP65 Control Units
- Temperature from -15°C to 70°C
- Range of colours to meet various needs

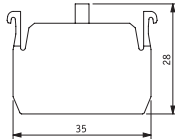

V:1

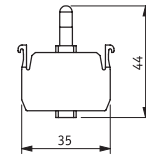
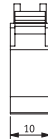

V:2

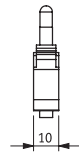

Part Number	Version	Type	Contact Type	LED Colour	Standard Pack Quantity
1339762	1	Contact block	1 NO	-	20
1339763	1	Contact block	1 NC	-	20
1339764	2	Illumination block with LED	12-30 V AC/DC	White	20
1339765	2	Illumination block with LED	12-30 V AC/DC	Red	20
1339766	2	Illumination block with LED	12-30 V AC/DC	Blue	20
1339767	2	Illumination block with LED	12-30 V AC/DC	Yellow	20
1339768	2	Illumination block with LED	12-30 V AC/DC	Green	20
1339769	2	Illumination block with LED	100-230 V AC	White	20
1339770	2	Illumination block with LED	100-230 V AC	Red	20
1339771	2	Illumination block with LED	100-230 V AC	Blue	20
1339772	2	Illumination block with LED	100-230 V AC	Yellow	20
1339773	2	Illumination block with LED	100-230 V AC	Green	20

Control Unit Accessories

SR 3014



Part Number	Version	Standard Pack Quantity
1339774	Silicon cover	20
1339775	Silicon Cover Double Head	20
1339776	Silicon Cover Double Head	100
1339777	Push Button Plate Holder 8mm	100
1339778	Push Button Plate Holder 18mm	100
1339779	Double Push Button Plate Holder 18mm	100
1339780	IP50 Push Button Plate 18mm	100
1339781	IP50 Push Button Plate 8mm	100

IP50 LED Pilot Lights with Contact Block

SR 3015

Polyamide

- To fit Ø22 mm cut out with flush finish
- Temperature from -15°C to 70°C
- Range of colours to meet various needs
- Operating current: 5-15mA
- Operating voltage: 100-230V AC



Part Number	Nominal Voltage	Colour	Standard Pack Quantity
1339840	12-30 V AC/DC	White	10
1339841	12-30 V AC/DC	Red	10
1339842	12-30 V AC/DC	Blue	10
1339843	12-30 V AC/DC	Yellow	10
1339844	12-30 V AC/DC	Green	10
1339845	100-250 V AC	White	10
1339846	100-250 V AC	Red	10
1339847	100-250 V AC	Blue	10
1339848	100-250 V AC	Yellow	10
1339849	100-250 V AC	Green	10

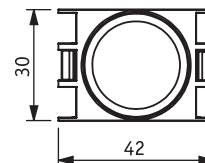
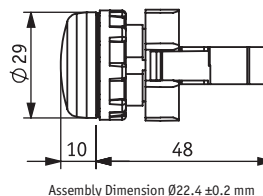

Assembly Dimension Ø22.4 ±0.2 mm

IP65 LED Pilot Lights with Contact Block

SR 3016

Polyamide

- To fit Ø22 mm cut out with flush finish
- Temperature from -15°C to 70°C
- Range of colours to meet various needs
- Available in metal and plastic finish
- Operating current: 5-15mA
- Operating voltage: 100-230V AC



Plastic



Metal

Part Number	Material	Nominal Voltage	Colour	Standard Pack Quantity
1339820	Plastic	12-30 V AC/DC	White	10
1339821	Plastic	12-30 V AC/DC	Red	10
1339822	Plastic	12-30 V AC/DC	Blue	10
1339823	Plastic	12-30 V AC/DC	Yellow	10
1339824	Plastic	12-30 V AC/DC	Green	10
1339825	Plastic	100-250 V AC	White	10
1339826	Plastic	100-250 V AC	Red	10
1339827	Plastic	100-250 V AC	Blue	10
1339828	Plastic	100-250 V AC	Yellow	10
1339829	Plastic	100-250 V AC	Green	10
1339830	Metal	12-30 V AC/DC	White	10
1339831	Metal	12-30 V AC/DC	Red	10
1339832	Metal	12-30 V AC/DC	Blue	10
1339833	Metal	12-30 V AC/DC	Yellow	10
1339834	Metal	12-30 V AC/DC	Green	10
1339835	Metal	100-250 V AC	White	10
1339836	Metal	100-250 V AC	Red	10
1339837	Metal	100-250 V AC	Blue	10
1339838	Metal	100-250 V AC	Yellow	10
1339839	Metal	100-250 V AC	Green	10

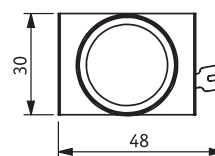
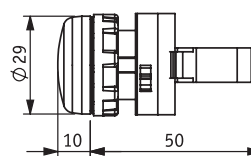

Assembly Dimension Ø22.4 ±0.2 mm

Monoblock Pilot Lights

SR 3017

Polyamide

- To fit Ø22 mm cut out with flush finish
- Temperature from -15°C to 70°C
- Range of colours to meet various needs

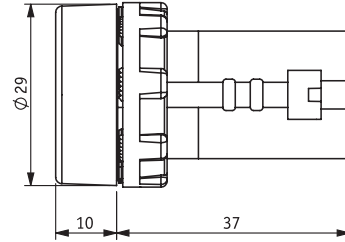

Assembly Dimension Ø22.4 ±0.2 mm

Part Number	Nominal Voltage	Colour	Standard Pack Quantity
1339854	24V AC/DC	Green	10
1339855	24V AC/DC	Red	10
1339856	24V AC/DC	Blue	10
1339857	24V AC/DC	White	10
1339858	24V AC/DC	Yellow	10
1339859	220V AC	Green	10
1339860	220V AC	Red	10
1339861	220V AC	Blue	10
1339862	220V AC	White	10
1339863	220V AC	Yellow	10

Monoblock Buzzers

SR 3018

Polyamide

- To fit Ø22 mm cut out with flush finish
- Temperature from -15°C to 70°C
- Range of colours to meet various needs

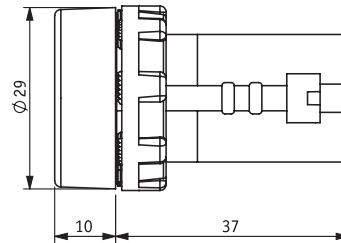

Assembly Dimension Ø22.4 ±0.2 mm

Part Number	Feature	Nominal Voltage	Colour	Standard Pack Quantity
1339864	LED illumination	24 AC/DC	Red	10
1339865	LED illumination	220V AC	Black	10
1339866	-	24 AC/DC	Red	10
1339867	-	220V AC	Black	10

Rocker Switch

SR 3019

PA 66

- Temperature from -15°C to 70°C
- Range of colours to meet various needs
- Rated current: 16 A NO+1NC
- Rated voltage: 250V AC

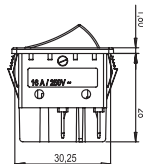
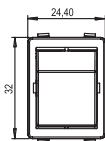

Part Number	Type	Light	Standard Pack Quantity
1339868	ON- OFF/1-0	Yes	1000
1339869	ON- OFF/1-0	No	1000
1339870	ON- OFF/1-0 4 Screw	Yes	750
1339871	ON- OFF/1-0 4 Screw	No	750
1339872	ON- OFF/1-0 clamp	Yes	750

Rocker Switch

SR 3020

PA 66

- Temperature from -15°C to 70°C
- Range of colours to meet various needs
- Rated current: 16 A NO+1NC
- Rated voltage: 250V AC

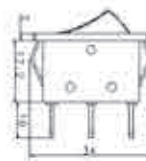

Part Number	Colour	Light	Standard Pack Quantity
1339873	Red	Yes	1500
1339874	Red	No	1500
1339875	Orange	Yes	1500

Rocker Switch

SR 3021

PA 66

- Temperature from -15°C to 70°C
- Range of colours to meet various needs
- Rated current: 16 A NO+1NC
- Rated voltage: 250V AC

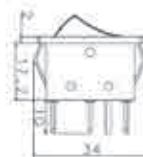

Part Number	Colour	Light	Standard Pack Quantity
1339876	Red	Yes	750
1339877	Red	No	750
1339878	Orange	Yes	750

Rocker Switch

SR 3022

PA 66

- Temperature from -15°C to 70°C
- Range of colours to meet various needs
- Rated current: 16 A NO+1NC
- Rated voltage: 250V AC

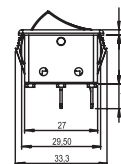
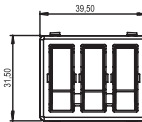

Part Number	Colour	Light	Standard Pack Quantity
1339879	Red	No	500
1339880	Orange	Yes	500

90° Safety On/Off Cam Switches

SR 3023

PA 66

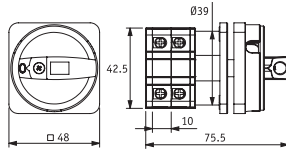

Contact Schema

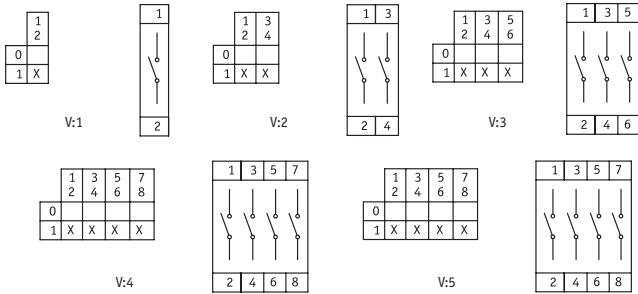

- Temperature from -15°C to 80°C
- TS EN 60947 -3
- Handle designed to fit finger ergonomy
- Operating Voltage: 220- 400V

Part Number	Poles	Schema Version	Rated Thermal Current (A)	Standard Pack Quantity
1339884	1	1	10	24
1339885	2	2	10	24
1339886	3	3	10	24
1339887	4	4	10	24
1339888	3 + Neutral	5	10	24
1339889	1	1	16	24
1339890	2	2	16	24
1339891	3	3	16	24
1339892	4	4	16	24
1339893	3 + Neutral	5	16	24
1339894	1	1	20	24
1339895	2	2	20	24
1339896	3	3	20	24
1339897	4	4	20	24
1339898	3 + Neutral	5	20	24
1339899	1	1	25	24
1339900	2	2	25	24
1339901	3	3	25	24
1339902	4	4	25	24
1339903	3 + Neutral	5	25	24

60° 0-1 On/Off Cam Switches

SR 3024

PA 66

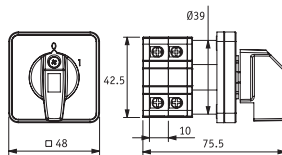

Contact Schema

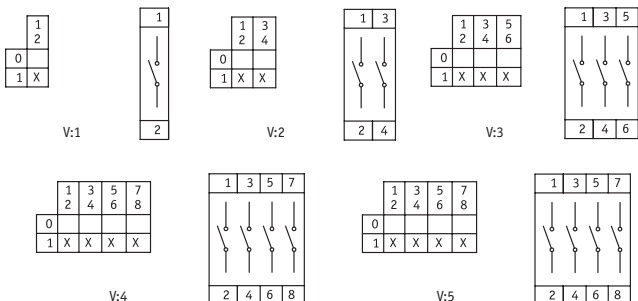

- Temperature from -15°C to 80°C
- TS EN 60947 -3
- Handle designed to fit finger ergonomy
- Operating Voltage: 400V

Part Number	Poles	Schema Version	Rated Thermal Current (A)	Standard Pack Quantity
1339904	1	1	10	24
1339905	2	2	10	24
1339906	3	3	10	24
1339907	4	4	10	24
1339908	3 + Neutral	5	10	24
1339909	1	1	16	24
1339910	2	2	16	24
1339911	3	3	16	24
1339912	4	4	16	24
1339913	3 + Neutral	5	20	24
1339914	1	1	20	24
1339915	2	2	20	24
1339916	3	3	20	24
1339917	4	4	20	24
1339918	3 + Neutral	5	20	24
1339919	1	1	25	24
1339920	2	2	25	24
1339921	3	3	25	24
1339922	4	4	25	24
1339923	3 + Neutral	5	25	24

Thermostat

SR 3025

- Operating temperature from -20°C to 80°C
- IP20
- 35 mm DIN Rail (EN50022) mounting
- UL94 V0 casting

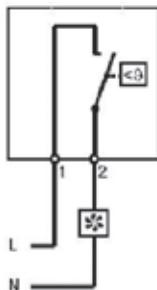

Cooling

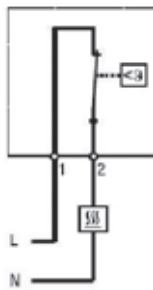

Heating

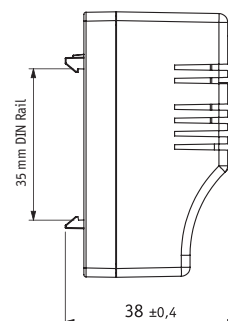
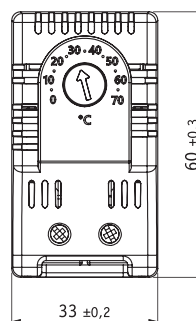

Part Number	Working Voltage	Type	Standard Pack Quantity
1339709	AC 24- 230V	Cooling	40
1339710	AC 24- 230V	Heating	40

QUESTIONS? Send us an email

Our Customer Service advisors can also help you find the right product for your application.

info@metalika-kacin.com
www.metalika-kacin.com



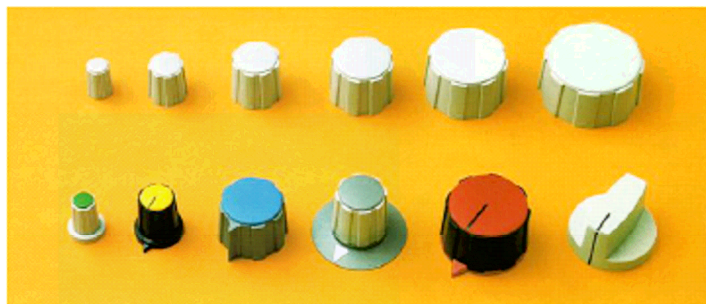

APARATNI GUMBI

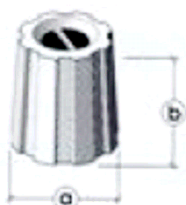

a	10	10	10	15	15	15	20	20
b	14	14	14	15,5	15,5	15,5	18	18
os	3	4	1/8	4	6	1/4	4	6
barva	1,3,7	1,3,7	1,3,7	1,3,7	1,3,7	1,3,7	1,3,7	1,3,7
šifra	2112	2102	2142	2212	2202	2242	2322	2302

a	20	25	25	32	32	40	40	40
b	18	18	18	18	18	18	18	18
os	1/4	6	1/4	6	1/4	6	8	1/4
barva	1,3,7	1,3,7	1,3,7	1,3,7	1,3,7	1,3,7	1,3,7	1,3,7
šifra	2342	2402	2442	2502	2542	2602	2612	2642

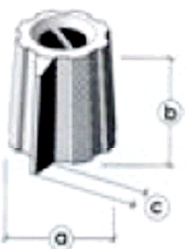

a	10	10	10	15	15	15	20	20
b	14	14	14	15,5	15,5	15,5	18	18
c	1,5	1,5	1,5	2	2	2	2,5	2,5
os	3	4	1/8	4	6	1/4	4	6
barva	1,3,7	1,3,7	1,3,7	1,3,7	1,3,7	1,3,7	1,3,7	1,3,7
šifra	2122	2132	2152	2222	2232	2252	2332	2312

a	20	25	25	32	32			
b	18	18	18	18	18			
c	2,5	2,7	2,7	3	3			
os	1/4	6	1/4	6	1/4			
barva	1,3,7	1,3,7	1,3,7	1,3,7	1,3,7			
šifra	2352	2412	2452	2512	2552			



a	10	10	10	15	15	15	
b	16,5	16,5	16,5	18,5	18,5	18,5	
c	2	2	2	3	3	3	
d	13,5	13,5	13,5	18	18	18	
os	3	4	1/8	4	6	1/4	
barve	1,3,7	1,3,7	1,3,7	1,3,7	1,3,7	1,3,7	
brez kaz	šifra	2114	2124	2144	2214	2224	2244
s kaz	šifra	2115	2125	2145	2215	2225	2245

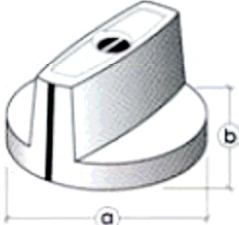



a	25	25	32	32	40	40
b	16,5	16,5	18,5	18,5	19	19
os	4	1/8	6	1/4	6	1/4
barve	1,3,7	1,3,7	1,3,7	1,3,7	1,3,7	1,3,7
šifra	2462	2432	2562	2532	2662	2632

POKROVČKI	za gumbe	10	15	20	25	32	40	
	barve	1,2,3,4,5,6,7	1,2,3,4,5,6,7	1,2,3,4,5,6,7	1,2,3,4,5,6,7	1,2,3,4,5,6,7	1,2,3,4,5,6,7	
	s črto	šifra	2141	2241	2341	2441	2541	
	brez črte	šifra	2101	2201	2301	2401	2501	2601



barve				1,3,7	1,3,7	1,3,7
šifra				2451	2551	2651

KAZALCI	za gumbe	10	15	20	25	32	40
	a	20	27	35	42	51	
	barve	1,3,7	1,3,7	1,3,7	1,3,7	1,3,7	
	šifra	2103	2203	2303	2403	2503	



b				4	5	6
barve				1,2,3,7	1,2,3,7	1,2,3,7
šifra				2408	2508	2608

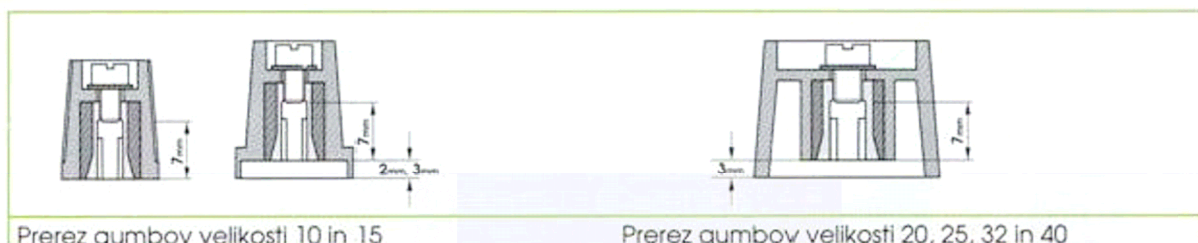

Šifre za barve



Primer za naročilo

izdelek	barva
2302	3

šifra za naročilo
23023