



**Advantages**

- Window seals are used to mount panes, windows, etc. in doors, casings and machine enclosures.
- **Note:** assembly only with filler. The pane is clamped in place with the help of the filler and held flush-mounted in the cutout.
- The window seals are made of EPDM with excellent weathering and ozone resistance properties.
- DIRAK's EPDM quality is neutral to paints.
- **Tested according to UL 157 and UL 50 E.**

**Materials**

- **Profile and filler:** EPDM

**Remarks**

1. Window
  2. Window seal
  3. Filler
  4. Sheet metal thickness
- Please dimension window with 1mm gap circumferentially.  
AS = size of window  
AB = size sheet metal  
Note Tolerances!

www.METALIKA-KACIN.com

Gaskets

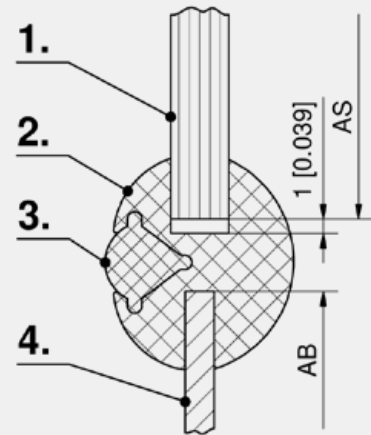
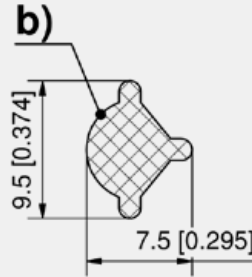
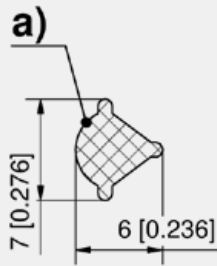
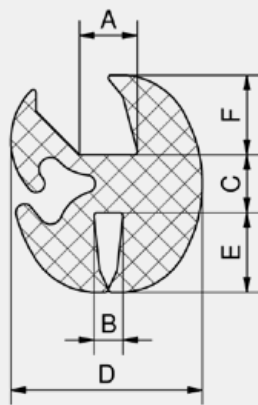

Window Seals

Part Number	Material	Colour	A	B	C	D	e	f	Bending radius	Filler	Packaging unit
209-0501.00-00000	EPDM	black	4 mm	2 mm	4 mm	13 mm	5.5 mm	5.5 mm	30	a)	20 m
209-0502.00-00000	EPDM	black	4 mm	2.5 mm	7 mm	16 mm	7 mm	7 mm	70	b)	20 m
209-0503.00-00000	EPDM	black	6 mm	2.5 mm	7 mm	18 mm	7 mm	7 mm	70	b)	20 m
209-0508.00-00000	EPDM	black	3 mm	1 mm	4 mm	11.6 mm	4.5 mm	6 mm	35	a)	20 m
209-0509.00-00000	EPDM	black	4 mm	1.5 mm	7 mm	16 mm	7 mm	7 mm	80	b)	20 m
209-0510.00-00000	EPDM	black	4 mm	2 mm	7.3 mm	18 mm	11 mm	8.7 mm	100	b)	15 m
209-0511.00-00000	EPDM	black	4.5 mm	5 mm	7 mm	16 mm	7 mm	7 mm	80	b)	20 m
209-0512.00-00000	EPDM	black	5 mm	2 mm	7.5 mm	19 mm	12.5 mm	9.5 mm	100	b)	15 m
209-0513.00-00000	EPDM	black	5 mm	3 mm	7 mm	19 mm	8 mm	8 mm	90	b)	20 m
209-0514.00-00000	EPDM	black	5 mm	3 mm	7.5 mm	19 mm	12.5 mm	9.5 mm	100	b)	15 m
209-0515.00-00000	EPDM	black	5 mm	5 mm	7 mm	18.4 mm	9 mm	8 mm	90	b)	20 m
209-0516.00-00000	EPDM	black	5.5 mm	2 mm	7.3 mm	19 mm	11 mm	8.7 mm	100	b)	15 m
209-0517.00-00000	EPDM	black	6 mm	1.5 mm	7.5 mm	19 mm	12.5 mm	9.5 mm	100	b)	15 m
209-0518.00-00000	EPDM	black	6 mm	2.5 mm	7 mm	19 mm	8 mm	8 mm	90	b)	20 m
209-0519.00-00000	EPDM	black	6 mm	3 mm	7.5 mm	19 mm	12.5 mm	9.5 mm	100	b)	15 m
209-0520.00-00000	EPDM	black	6 mm	4 mm	7.5 mm	19 mm	12.5 mm	9.5 mm	100	b)	15 m
209-0521.00-00000	EPDM	black	6 mm	6 mm	8.5 mm	19 mm	9.5 mm	9 mm	100	b)	15 m
209-0522.00-00000	EPDM	black	8 mm	3 mm	7.5 mm	22 mm	12.5 mm	9.5 mm	120	b)	15 m
209-0523.00-00000	EPDM	black	8 mm	4 mm	8.5 mm	25 mm	12.5 mm	10 mm	100	b)	15 m
209-0524.00-00000	EPDM	black	10 mm	3 mm	7.5 mm	23 mm	12.5 mm	9.5 mm	120	b)	15 m
209-0525.00-00000	EPDM	black	10 mm	6 mm	7.5 mm	24 mm	12.5 mm	9.5 mm	100	b)	15 m

Specific accessories	
b)	209-0602.00-00000 Filler
a)	209-0601.00-00000 Filler

Accessories	
678	209-1003.00-00000 Fitting tool for window seals, incl. eye 701-7068
678	701-7066.00-00000 Eye for fitting tool, small



**Advantages**

- Window seals are used to mount panes, windows, etc. in doors, casings and machine enclosures.
- **Note:** assembly only **with** filler. The pane is clamped in place with the help of the filler and held flush-mounted in the cutout.
- The window seal is made of EPDM with excellent weathering and ozone resistance properties.
- DIRAK's EPDM quality is neutral to paints.
- **Tested according to UL 157 and UL 50 E.**

**Materials**

- **Window seals:** EPDM

**Remarks**

1. Window
  2. Profile
  3. Filler
  4. Sheet metal thickness
- Please dimension window with 1 mm gap circumferentially.  
 AS = size of window  
 AB = size sheet metal  
 Note Tolerances!

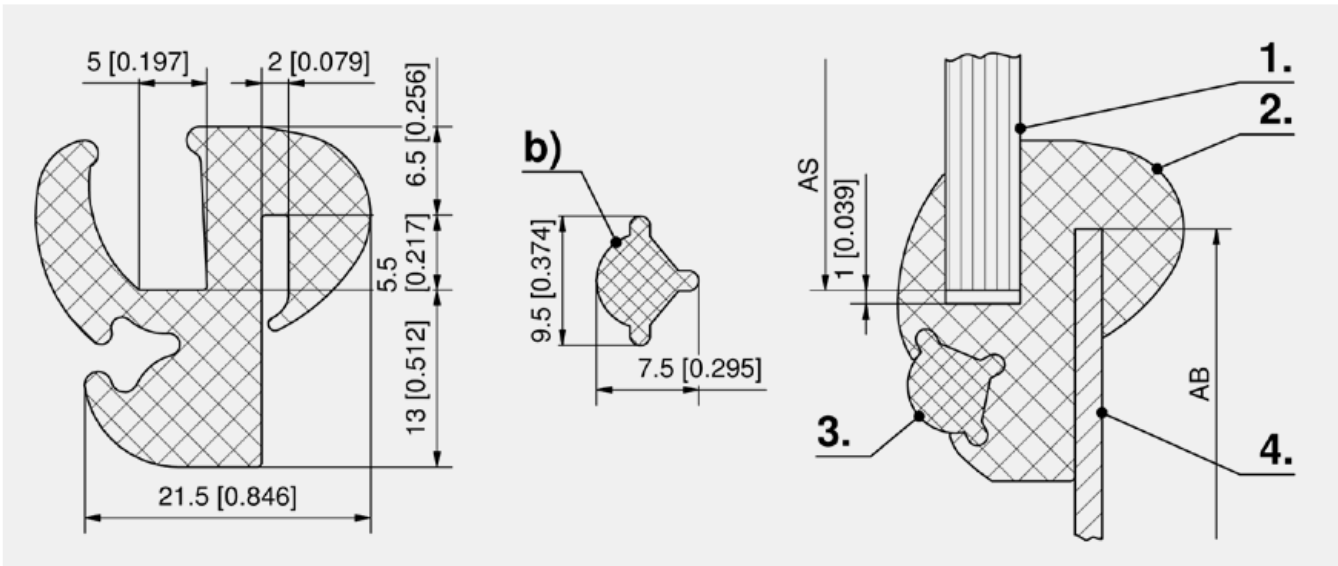

Window Seal

Part Number	Material	Colour	Width W	Height H	Packaging unit
209-0504.00-00000	EPDM	black	21.5 mm	25 mm	15 m

Specific accessories	
b) 209-0602.00-00000	Filler



RoHS  
WEEE



**Advantages**

- Window seals are used to mount panes, windows, etc. in doors, casings and machine enclosures.
- They are made of EPDM / NBR. The pane is mounted by simply pressing it into the window seal.
- Additional tools are not required. The pane is inside or outside the enclosure and hence is well-suited for use under high pressure or vacuum conditions.
- **EPDM seals are tested according to UL 157 and UL 50E.**

**Materials**

- **Rubber quality:** EPDM or Perbunan (NBR), NBR is oil-resistant

**Remarks**

Please dimension window with 1,5 mm gap circumferentially.  
All standard window seals are available from stock.  
Note Tolerances!

www.METALIKA-KACIN.com

Gaskets

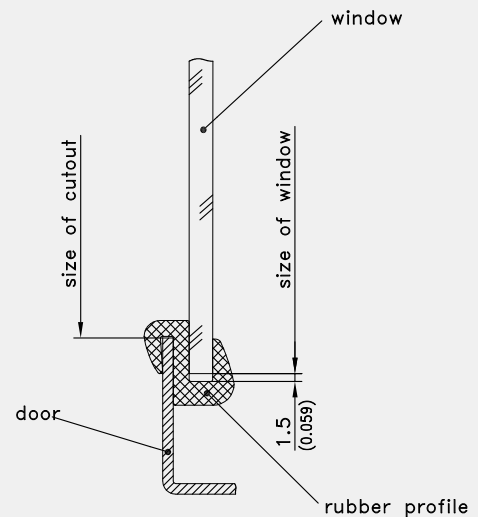
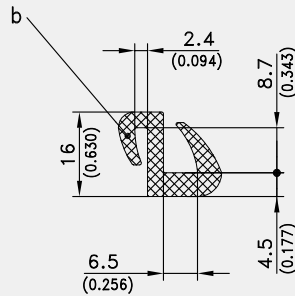
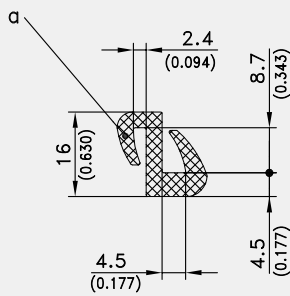

Window Seals

	Part Number	Material	Colour	Bending radius	Glass thickness	Sheet thickness	Height H	Packaging unit
a)	209-0401.00-00000	EPDM	black	min 80	4.5 mm	2.4 mm	16 mm	100 m
b)	209-0402.00-00000	EPDM	black	min 80	6.5 mm	2.4 mm	16 mm	100 m
a)	209-0406.00-00000	NBR	black	min 80	4.5 mm	2.4 mm	16 mm	100 m
b)	209-0407.00-00000	NBR	black	min 80	6.5 mm	2.4 mm	16 mm	100 m